

100282740

Thermostatic valve 2 way with wax thermo-element. 3/4" connectors. Integrated shut off. The flowrate at 3 bar (mixed water) for 1 water way is 36,5 l/min. For 2 water ways at the same time simultaneously is 39,5 l/min to be shared between both of them. Includes non-return valves and 38°C security stop.

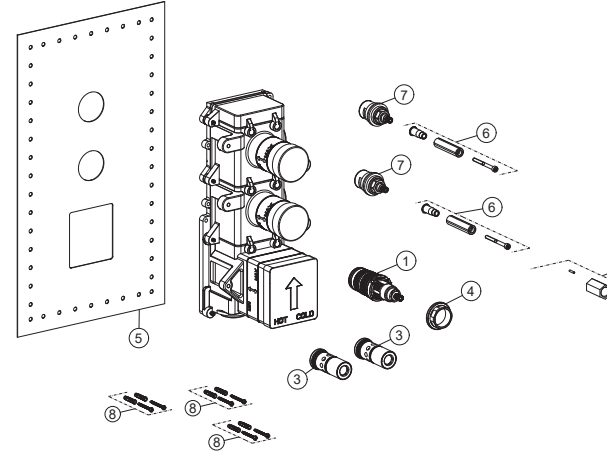

Extension kit

OPTION	SAP	FINISH	DIMENSION
1	100286512	-	25 mm
2	100286522	-	50 mm

Spare parts

POS.	SAP	ART.	RRP*
1	100286182	THERMOSTATIC CARTRIDGE OXO	-
2	100286144	ALIGNMENT TOOL OXO HANDLE THERM.	-
3	100286162	THERMOSTATIC FILTER OXO	-
4	100286145	THERM. CART. FIXING NUT OXO	-
5	100286183	WALL ISOLATION SHEET OXO THERM 2 WAYS	-
6	100286147	FIXING NUT FOR FLOW HANDLE THERM OXO	-
7	100286164	FLOW RATE HEADWORK OXO THERM	-
8	100296803	PAIR OF SCREWS AND ANCHORS OXO THERM	-