

100324543  
100324544  
100324535  
100324536



100324556  
100324514  
100324515  
100324517



100324533  
100324499  
100324516  
100324531

**noken**  
PORCELANOSA BATHROOMS

Carretera CV-20 km.2 · 12540 Vila-real · Castellón · Spain  
Tel: +34 964 50 64 50 - Fax: +34 964 50 67 93  
e-mail: [noken@noken.com](mailto:noken@noken.com) · [www.noken.com](http://www.noken.com)

**LIGNAGE  
CARRARA**



### Antes de la instalación y la puesta en funcionamiento

**¡Cuidado!** Los tubos de alimentación tienen que ser enjuagados escrupulosamente antes de instalar el dispositivo de manera que no haya virutas, residuos de soldadura o cáñamo u otras impurezas al interior de los tubos. A través de los tubos no perfectamente enjuagados o de la red hídrica general pueden entrar en el dispositivo unos cuerpos extraños que pueden dañar guarniciones/juntas tóricas.

Les recomendamos por lo tanto que instalen los filtros en la planta general también.

Recomendamos instalar válvulas reductoras de presión para presiones superiores a las indicadas en la tabla de datos técnicos.

-El respeto de dichas indicaciones, mantiene los derechos de garantía, garantiza las características declaradas de los productos y asegura su perfecta fiabilidad.

### Before installation and setting to work.

**Attention!** The feeding pipes have to be rinsed carefully before the installation of the device so that there won't remain shavings, sealing or hemp residues, or other impurities inside the pipes. Through pipes not thoroughly rinsed or through the general water network, in the device foreign bodies can enter that could damage gaskets /o-ring.

So filters should be installed also on the general system.

We recommend the installation of pressure reducing valves for pressures superior than those indicated in the technical data table.

-Respecting this indications, will maintain the warranty rights, ensures the declared properties of the products and warrant the complete reliability.

### Avant l'installation et la mise en fonction.

**Attention!** Les tuyaux d'alimentation doivent être rincés avec soin avant l'installation du dispositif, de sorte que ils ne restent pas de copeaux, des restes de soudage ou de chanvre, ou d'autres impuretés à l'intérieur des tuyaux. A travers les conduites non rincées à fond ou à travers le réseau hydrique général, dans le dispositif peuvent entrer des corps étrangers à même de détériorer les gaines/o-ring.

On recommande ainsi d'installer des filtres également sur le système général.

Nous recommandons d'installer les réducteurs de pression pour des pressions supérieures à indiquées dans le tableau des données techniques.

-Le respect de ces indications, assure les droits de garantie, garantit les caractéristiques déclarées des produits et il en assure la complète fiabilité.

### Antes da instalação e colocada em funcionamento

**Cuidado!** Os tubos de alimentação têm que ser cuidadosamente lavados, antes de se instalar o dispositivo de maneira a que não haja chips, resíduos de solda ou canhamo ou outras impurezas no interior dos tubos. Através dos tubos que não estejam cuidadosamente lavados ou através da rede de água geral, podem entrar no dispositivo corpos estranhos que podem danificar as juntas /o-rings.

Recomendamos por isso que se instalem filtros também na planta geral

Recomendamos a instalação de válvulas reductoras de pressão acima indicados nas pressões da tabela de dados técnicos

Com o cumprimento destas instruções, a garantia permanece, garante as características declaradas dos produtos e garante sua perfeita confiança





- Lea atentamente estas instrucciones antes de comenzar la instalación.
- Compruebe el producto por si faltasen piezas o estuviesen dañadas.
- Cualquier alteración que se realice a la grifería invalidará la garantía.
- Le recomendamos la instalación por parte de personal cualificado.
- En nuevas construcciones se deben llenar los sifones de inodoros, lavabos y bidés de agua para evitar que la grifería se oxide por efecto de la subida de gases corrosivos. Se recomienda que el espacio esté muy aireado.
- Purgar las tuberías antes de la instalación para arrastrar la suciedad.
- Gracias a un cuidado periódico, se pueden evitar calcificaciones.
- Residuos de productos de aseo como jabón líquido, champú y gel de ducha, también pueden dañar los materiales.
- Las griferías no deben instalarse en ambientes donde la temperatura pueda descender de 0°C, dado que la congelación de las tuberías podría dañar la grifería.

- Please read these instructions carefully before starting installation and retain it for future reference.
- Please leave this instructions with the end user.
- Remove all packaging and check the product for missing parts and damages before starting the installation.
- Any alterations made to this product and its fittings may infringe the water regulations and will invalidate the guarantee.
- We strongly recommend the use of a qualified and registered plumber.
- In new buildings it is recommended to water fill the traps to ensure toxic gases do not corrode the surface of the taps. It is recommended that the room is well ventilated.
- Thoroughly flush through all pipe work prior to the installation of terminal appliances, e.g. Shower heads, taps, inlet valves, etc.
- Periodic cleaning and maintenance should be use to avoid the build up of damaging limestone deposits.
- Bathroom beauty products such as liquid soap, shampoo or shower gels may damage some materials.
- Faucets do not have to be installed in environments where temperature may drop below 0°C as frozen pipes may damage faucets.

- Lire attentivement cette notice avant de commencer l'installation.
- Vérifier si certaines pièces sont manquantes au abîmées.
- Toute altération qui sera effectuée à la robinetterie rendra invalide la garantie.
- Nous recommandons fortement l'installation du produit par du personnel qualifié.
- Dans le cas de constructions neuves, il faut mettre en eau les WC, lavabos et bidets pour éviter que la robinetterie s'oxyde à cause de gaz corrosif. Nous recommandons de laisser un espace très aéré.
- Purger les tuyauteries avant l'installation.
- Grâce à un entretien régulier, on peut éviter la formation de calcaire.
- Des résidus de produits de toilettes comme le savon liquide, le shampoing et le gel de douche peuvent également endommager les produits.
- Les robinetteries ne doivent pas être installées à des températures inférieures à 0°C, étant donné que la congélation des tuyauteries peut abîmer la robinetterie.

- Leia atentamente estas instruções antes de iniciar a instalação.
- Verifique o produto se ele estiver danificado ou se faltarem peças.
- Qualquer alteração que seja feita à torneira invalidará a garantia.
- Recomendamos a instalação por pessoal qualificado.
- Em novas construções devem –se colocar , sifões sanitários, pias e bidés , torneiras de água para prevenir a ferrugem devido ao aumento de gases corrosivos. Recomenda-se que o espaço seja muito arejado.
- Lavar os tubos antes da instalação para arrastar a sujidade.
- Com cuidados regulares, pode-se impedir a calcificação.
- Produtos de higiene pessoal, como sabonete líquido , champô e gel de banho, também pode danificar materiais.
- As torneiras não deveriam se instalar onde a temperatura pode descer de 0°C, desde o gelar dos tubos poderia danificar a torneira.





acabado/finished finition/acabamento	100324543	
	1	100323975
	2	100323992
cromo/chrome/chrome/cromo	3	100267025
cromo/chrome/chrome/cromo	4	100304837
	5	100040151
cromo/chrome/chrome/cromo	6	100267041
	7	100040152

acabado/finished finition/acabamento	100324544	
	1	100323975
	2	100323992
oro/gold/or/ouro	3	100266997
oro/gold/or/ouro	4	100304845
	5	100040151
oro/gold/or/ouro	6	100266999
	7	100040152

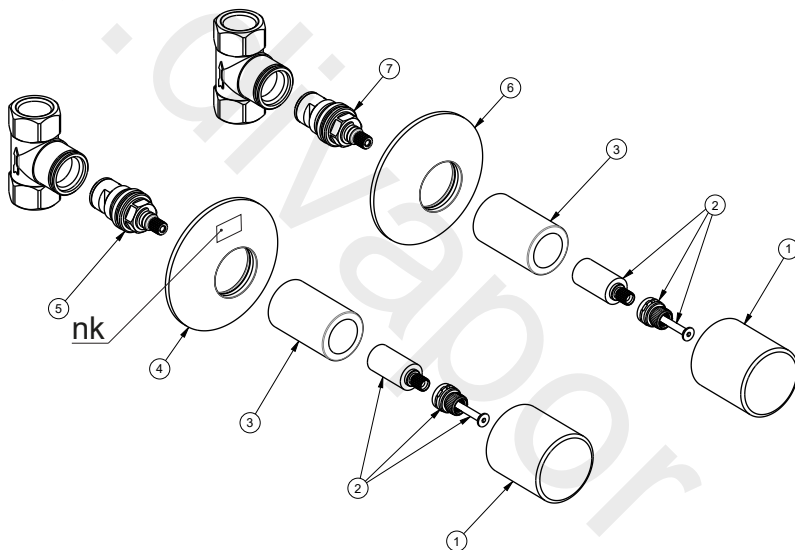

acabado/finished finition/acabamento	100324535	
	1	100323975
	2	100323992
cobre cepillado/brushed copper cuivre brossé/cobre escovado	3	100296545
cobre cepillado/brushed copper cuivre brossé/cobre escovado	4	100304838
	5	100040151
cobre cepillado/brushed copper cuivre brossé/cobre escovado	6	100296536
	7	100040152

acabado/finished finition/acabamento	100324536	
	1	100323975
	2	100323992
oro cepillado/brushed gold or brossé/ouro escovado	3	100299754
oro cepillado/brushed gold or brossé/ouro escovado	4	100304846
	5	100040151
oro cepillado/brushed gold or brossé/ouro escovado	6	100299736
	7	100040152





acabado/finished finition/acabamento	100324556	
	1	100323975
	2	100324146
cromo/chrome/chrome/cromo	3	100267026
cromo/chrome/chrome/cromo	4	100267073
	5	100267032
	6	100267040
cromo/chrome/chrome/cromo	7	100267054

acabado/finished finition/acabamento	100324514	
	1	100323975
	2	100324146
oro/gold/ori/ouro	3	100267027
oro/gold/ori/ouro	4	100267074
	5	100267032
	6	100267040
oro/gold/ori/ouro	7	100267055

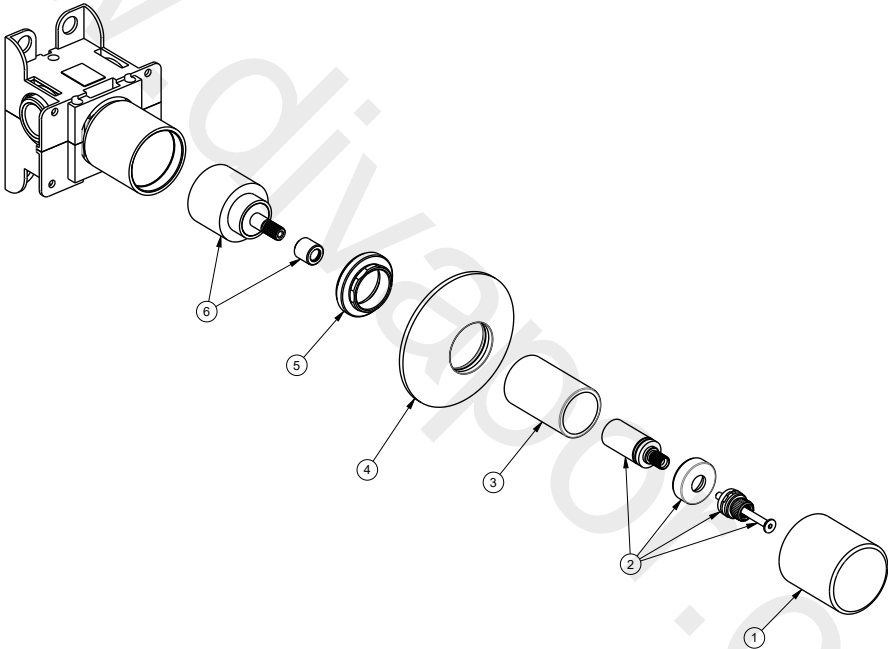

acabado/finished finition/acabamento	100324515	
	1	100323975
	2	100324146
cobre cepillado/brushed copper cuivre brossé/cobre escovado	3	100296554
cobre cepillado/brushed copper cuivre brossé/cobre escovado	4	100296548
	5	100267032
	6	100267040
cobre cepillado/brushed copper cuivre brossé/cobre escovado	7	100296561

acabado/finished finition/acabamento	100324517	
	1	100323975
	2	100324146
oro cepillado/brushed gold or brossé/ouro escovado	3	100299727
oro cepillado/brushed gold or brossé/ouro escovado	4	100299726
	5	100267032
	6	100267040
oro cepillado/brushed gold or brossé/ouro escovado	7	100299782





acabado/finished finition/acabamento	100324533	
	1	100323975
	2	100324166
cromo/chrome/chrome/cromo	3	100267026
cromo/chrome/chrome/cromo	4	100267045
	5	100267051
	6	100267031

acabado/finished finition/acabamento	100324499	
	1	100323975
	2	100324166
oro/gold/or/ouro	3	100267027
oro/gold/or/ouro	4	100267036
	5	100267051
	6	100267031

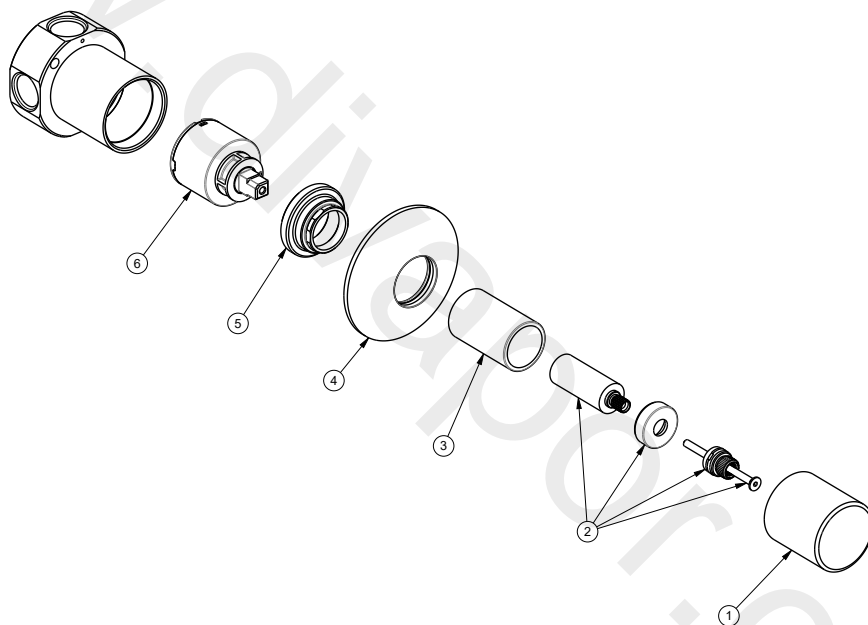

acabado/finished finition/acabamento	100324516	
	1	100323975
	2	100324166
cobre cepillado/brushed copper cuivre brossé/cobre escovado	3	100296554
cobre cepillado/brushed copper cuivre brossé/cobre escovado	4	100296527
	5	100267051
	6	100267031

acabado/finished finition/acabamento	100324531	
	1	100323975
	2	100324166
oro cepillado/brushed gold or brossé/ouro escovado	3	100299727
oro cepillado/brushed gold or brossé/ouro escovado	4	100299699
	5	100267051
	6	100267031





100324543 - 100324544  
100324535 - 100324536

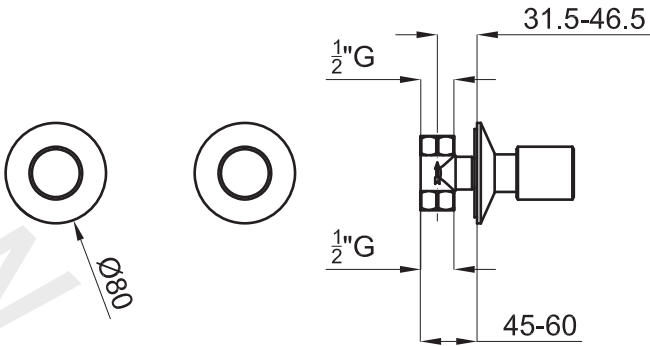

100324556 - 100324514  
100324515 - 100324517

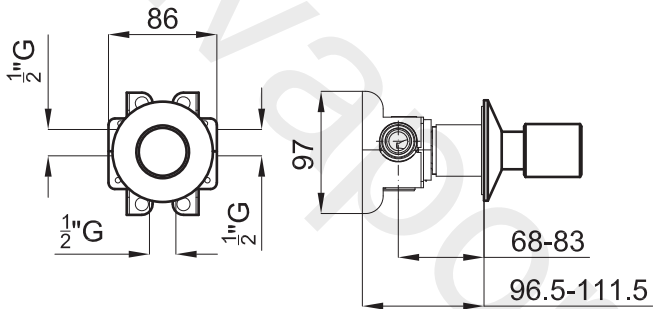

100324533 - 100324499  
100324516 - 100324531

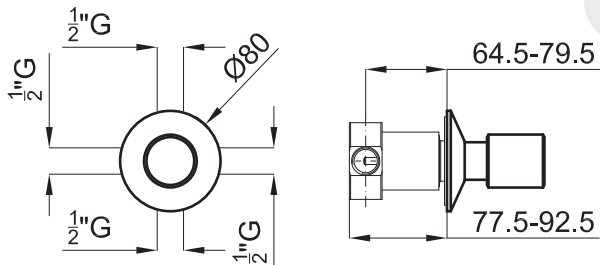



1

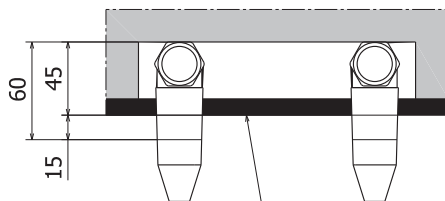
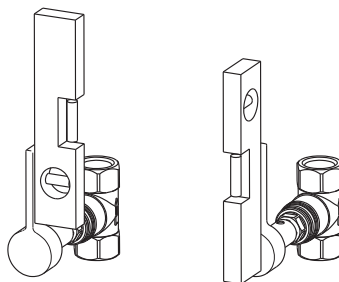
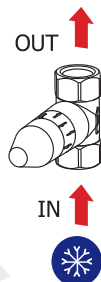

BORDE DE REVESTIMIENTO EXTERNO  
LINE OF THE EXTERNAL FACING  
FIL DU REVETEMENT EXTERNE  
BORDA DO REVESTIMENTO EXTERNO

100324543 - 100324544  
100324535 - 100324536

2

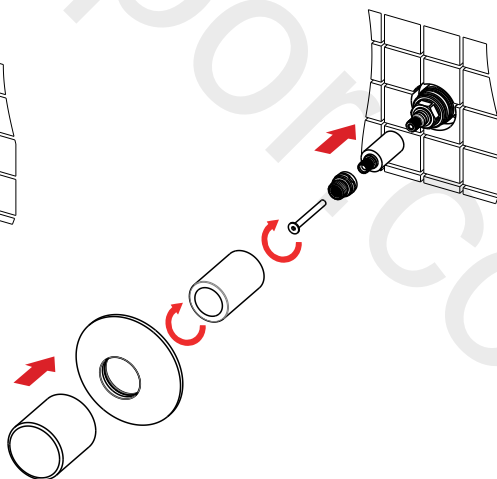
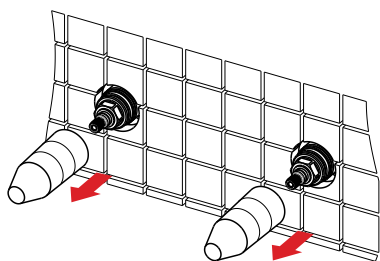

100324543 - 100324544  
100324535 - 100324536







1

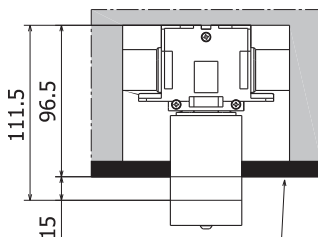
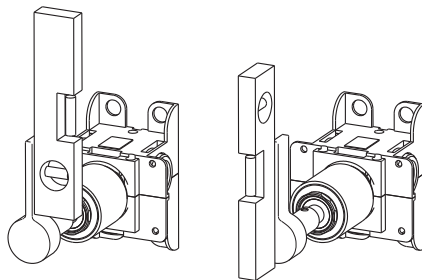
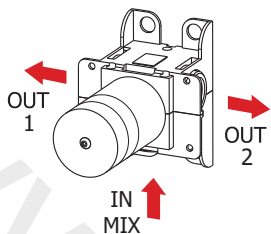

BORDE DE REVESTIMIENTO EXTERNO  
LINE OF THE EXTERNAL FACING  
FIL DU REVETEMENT EXTERNE  
BORDA DO REVESTIMENTO EXTERNO

100324556 - 100324514  
100324515 - 100324517

2

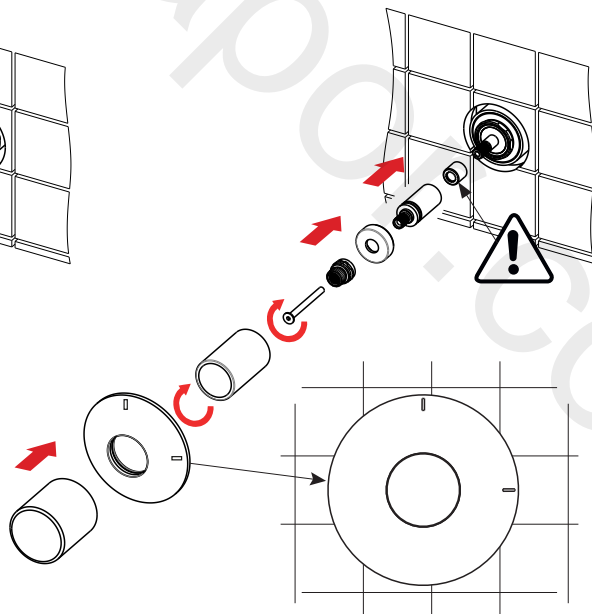
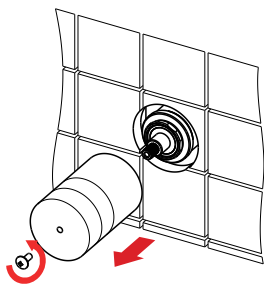

100324556 - 100324514  
100324515 - 100324517





1

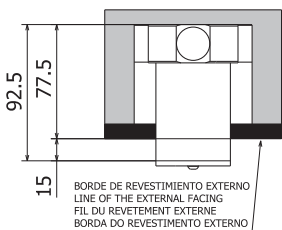
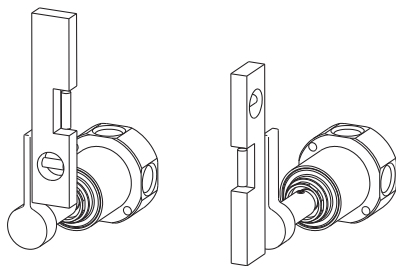
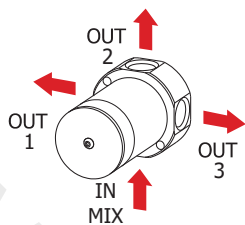

100324533 - 100324499  
100324516 - 100324531

2

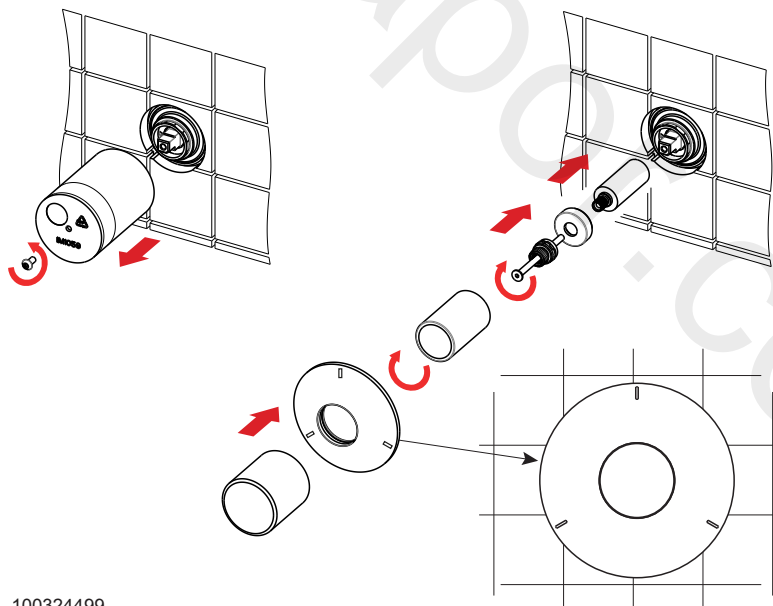

100324533 - 100324499  
100324516 - 100324531



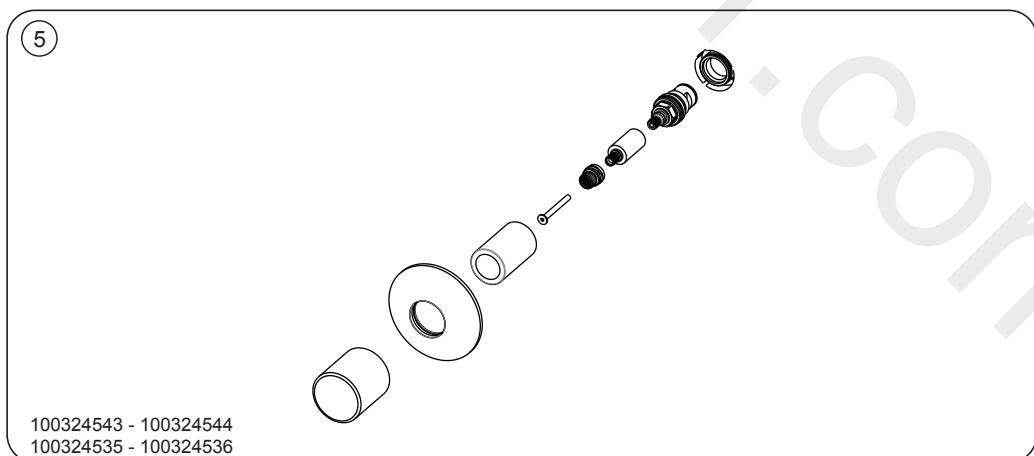
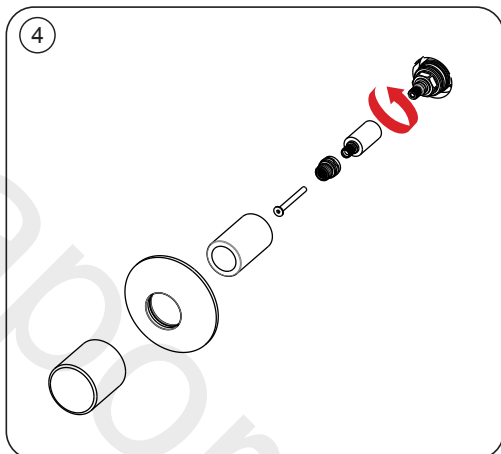
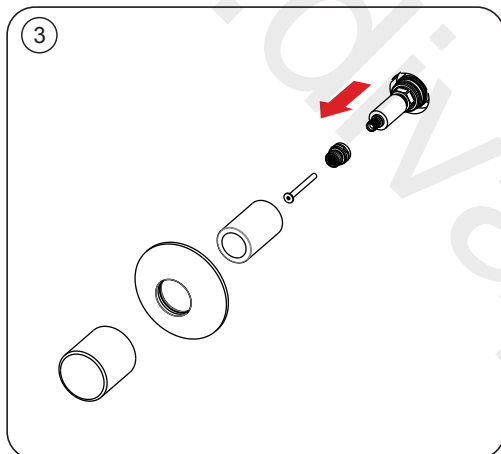
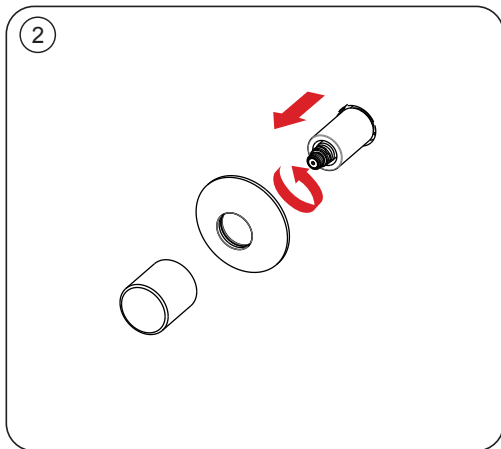
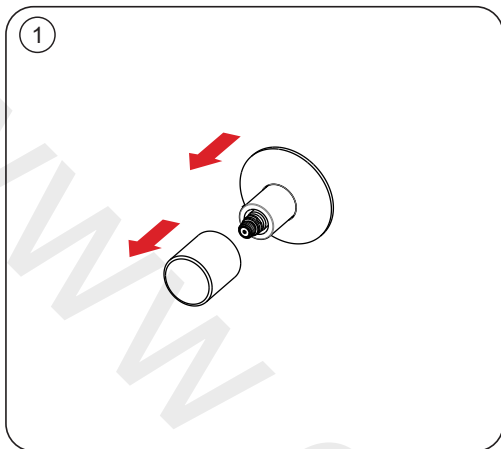

100324543 - 100324544  
100324535 - 100324536





3

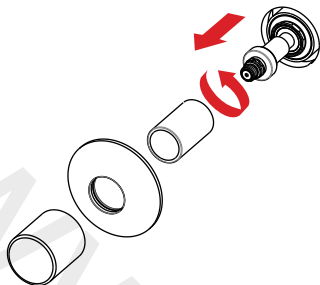

100324556 - 100324514  
100324515 - 100324517

100324533 - 100324499  
100324516 - 100324531

4

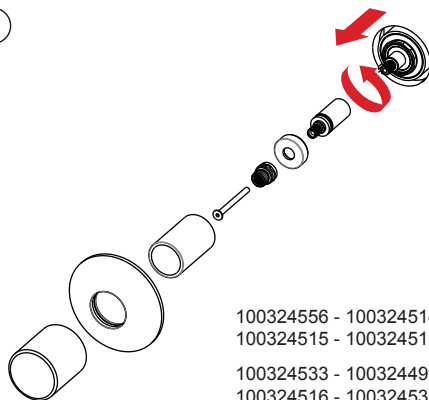

100324556 - 100324514  
100324515 - 100324517

100324533 - 100324499  
100324516 - 100324531

5

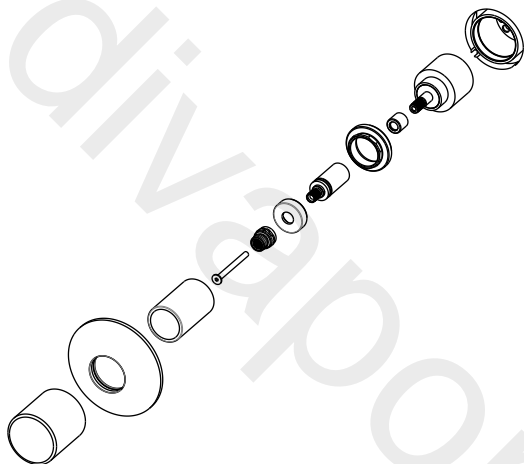

100324556 - 100324514  
100324515 - 100324517

5

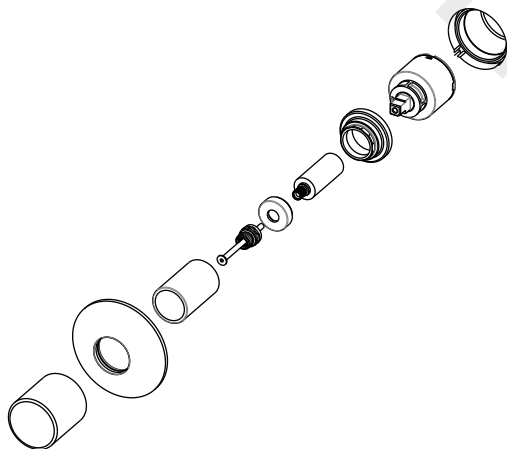

100324533 - 100324499  
100324516 - 100324531



100324543 - 100324544  
 100324535 - 100324536

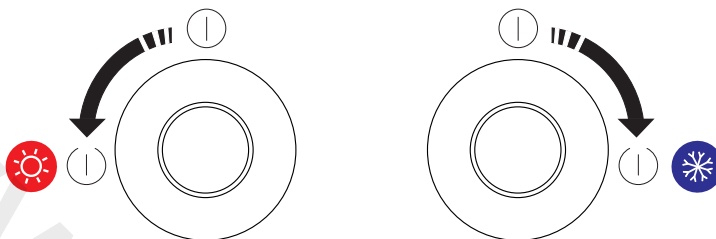



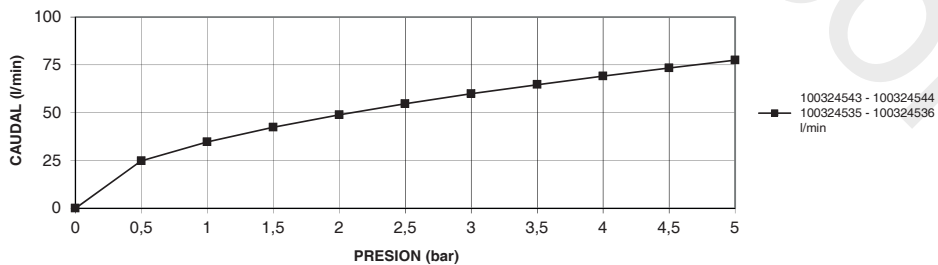

	Min.-Max. 0,5 - 5 bar		Max. 70°C	Mixing system	
	Max. 5 bar		3 bar	Material	Brass
				Coating	chrome nickel
					≥ 0,25 µm ≥ 10 µm

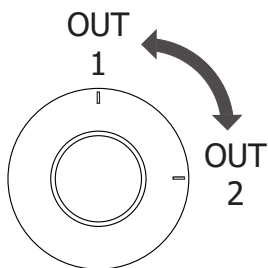
	100324543 - 100324544 100324535 - 100324536
PRESION (BAR)	CAUDAL (L/MIN)
0	0
0,5	24,82
1	34,72
2	48,90
3	59,94
4	69,18
5	77,51









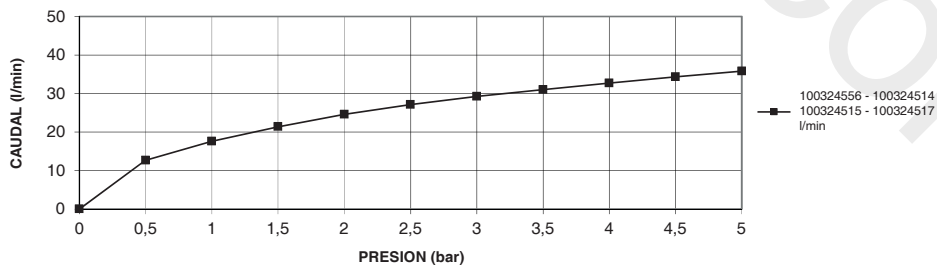

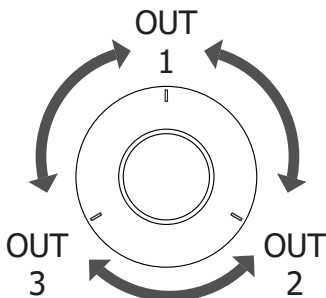
	Min.-Max. 0,5 - 5 bar		Max. 70°C	Mixing system	
	Max. 5 bar		3 bar	Material	Brass
				Coating	chrome nickel
					≥ 0,25 µm ≥ 10 µm

	100324556 - 100324514 100324515 - 100324517
PRESION (BAR)	CAUDAL (L/MIN)
0	0
0,5	12,67
1	17,59
2	24,59
3	29,23
4	32,71
5	35,81





	Min.-Max. 0,5 - 5 bar		Max. 70°C	Mixing system	
	Max. 5 bar		3 bar	Material	Brass
				Coating	chrome nickel
					≥ 0,25 µm ≥ 10 µm

PRESION (BAR)	out 1	out 2	out 3
	CAUDAL (L/MIN)	CAUDAL (L/MIN)	CAUDAL (L/MIN)
0	0	0	0
0,5	12,19	11,27	11,80
1	17,28	15,77	16,36
2	24,28	22,16	23,06
3	29,72	27,09	28,15
4	34,33	31,36	32,44
5	38,40	35,51	36,44

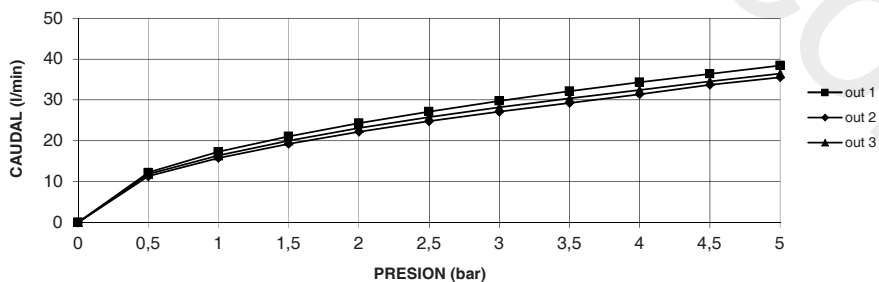



## GRIFERÍAS Y ACCESORIOS

En primer lugar, agradecerle la adquisición de productos Noken. Todos los productos Noken están fabricados con la confianza de dar un servicio fiable durante muchos años. Al igual que las griferías de otros fabricantes nuestros productos también exigen un cuidado apropiado y un mantenimiento que asegure a su baño una imagen impecable.

## SUPERFICIE DE LAS GRIFERÍAS

Conforme a los requerimientos de la norma DIN EN 248 la capa de protección que habitualmente más se utiliza para la fabricación de las griferías se compone de metales como cromo, níquel, acero y latón, así como de otros para evitar la humedad. Antes de emprender la limpieza es necesario examinar con exactitud el tipo de superficie que se vaya a limpiar.

## LIMPIEZA

Para la limpieza de las griferías y de los accesorios ha de tenerse en cuenta que:

- Para la limpieza periódica utilice agua caliente mezclada con jabón, si esto no es posible también puede usar geles o limpiadores líquidos, enjuagando siempre a fondo con agua limpia tras su uso.
- Aunque fueran empleados una sola vez, no debe utilizarse ningún producto que contenga ácido fosfórico, clorhídrico, muriático, fórmico o acético, ya que podrían producir daños considerables. Utilice un PH neutro.
- Secar los artículos tras cada sesión de limpieza y tras cada uso para evitar la acumulación de cal.

## ADVERTENCIA

- Los productos de limpieza acentúan el deterioro en caso de que las superficies ya se encuentren dañadas.
- No mezcle limpiadores, las reacciones químicas pueden emitir gases tóxicos.
- No use estropajos agresivos ni limpiadores abrasivos.
- Bajo ningún concepto se debe utilizar para la limpieza de estas superficies lejías de blanquear con cloro.
- Únicamente deben utilizarse los productos de limpieza expresamente indicados por los fabricantes para cada tipo de superficie y acabado.

## RECOMENDACIONES PARA LA LIMPIEZA Y CONSERVACIÓN DE GRIFERÍAS Y ACCESORIOS

- Lea primero las instrucciones del fabricante.
- La limpieza periódica reducirá la formación de cal y suciedad.
- Los productos de limpieza no debe emplearse durante más tiempo del necesario.
- Si utiliza productos de limpieza con pulverizador, no pulverice directamente sobre la grifería y los accesorios, aplíquelo sobre un paño o una esponja. El líquido pulverizado podría introducirse por los huecos y grietas de la grifería y los accesorios pudiendo causar daños irreversibles.
- Si el grifo gotea puede causar manchas y placas de cal, por favor asegúrese de que quede correctamente cerrado.
- Si es necesario puede usar su limpiador anti-cal habitual, pero lea primero las instrucciones del fabricante y tras su uso enjuague siempre la grifería con agua limpia.
- Para proteger la mecánica de la grifería y alargar la vida útil de ésta, Noken recomienda la instalación de llaves de paso con filtros.

## CLÁUSULA REFERENTE A LA GARANTÍA

No respetar las indicaciones de mantenimiento puede tener como consecuencia la invalidación de la garantía.

## BRASSWARE AND ACCESSORIES

First of all we thank you for buying our products which are manufactured to the highest standards. However in common with other products our brassware requires the correct cleaning and periodic maintenance.

## BRASSWARE SURFACES

As stated in the norm DIN EN 248 the materials used to plate brassware are Chrome, Nickel, stainless steel, brass and others to leave a superior, easy to clean, pleasing finish. Before cleaning please check the material used and only use a suitable cleaner.

## CLEANING

To clean brassware and accessories please note the following recommendations.

- For regular cleaning only use warm soapy water, if this is not possible use soft non abrasive gels or similar cleaning products, rinse thoroughly and polish with a soft cloth.
- Please avoid the use of harsh or abrasive products such as scouring powders, those products with phosphoric acid, hydrochloric acid, formic acid or acetic acid that could badly damage the product. Please only use PH neutral products.
- Dry the items after each cleaning session and after every use to avoid limestone appearance.

## WARNING

- Cleaning materials will only worsen already damage product.
- Do not mix cleaning products, the chemical reactions can emit toxic fumes and react badly with product surfaces.
- Do not use harsh or abrasive cloths, pads or cleaning products.
- Do not use bleach or other chlorine based cleaning products.
- Only use suitable cleaning products as recommended for each product the cleaning products only make worse the surfaces if those are already damages.

## RECOMMENDATIONS FOR THE CLEANING AND PRESERVATION OF BRASSWARE AND ACCESSORIES

- Read the manufacturers instructions.
- To protect the brassware, internal mechanism and to extend the life of the product it is recommended in line with "best practice" to install isolation valves and in line filters.
- Regular cleaning to reduce lime scale and soap residue build up.
- Do not leave these products in contact with the product surface longer than the manufacturer's recommendations and rinse thoroughly with clean water.
- Do not spray cleaning products directly onto the product surface, spray onto a soft cloth and then apply to the product. Spraying directly onto the product can lead to cleaning fluids being drawn into the products through capillary action causing irreversible damage.
- If a tap is left dripping it may lead to staining and lime scale build up. Please ensure taps are correctly turned off after use.

## GUARANTEE CLAUSE

- Failure to comply with the maintenance instructions may invalidate the guarantee.







## ROBINETTERIES ET ACCESSOIRES

Tout d'abord, nous tenons à vous remercier pour avoir choisi un produit Noken. Tous nos produits sont fabriqués dans le but de donner un service fiable durant de nombreuses années. Pour assurer une image impeccable de votre salle de bains, nos robinetteries, comme celles d'autres fabricants, nécessitent un soin et un entretien approprié.

### LES SUPERFICIES DES ROBINETTES

Conformément aux exigences de la norme DIN EN 248, la couche de protection qui s'utilise le plus souvent pour la fabrication des robinetteries se compose de métaux tels que le chrome, le nickel, l'acier et le laiton ainsi que certains autres pour éviter l'humidité. Avant de commencer l'entretien, il est nécessaire d'examiner avec exactitude le type de superficie qui se nettoiera.

#### ENTRETIEN

Pour l'entretien des robinetteries et des accessoires, il faut prendre en compte certains détails:

- Pour l'entretien régulier, utiliser de l'eau chaude mélangée avec du savon. Si ce n'est pas possible, on peut utiliser des gels ou des produits d'entretien liquides, en rinçant toujours intensément avec de l'eau propre après usage.
- Ne pas utiliser de produits contenant de l'acide phosphorique, chlorhydrique, muriatique, formique ou acétique, même une seule fois, vu qu'ils pourraient occasionner des dégâts considérables. Utiliser un PH neutre.
- Séchez les articles après chaque session de nettoyage et après chaque utilisation pour éviter l'accumulation du calcaire.

#### AVERTISSEMENT

- Les produits d'entretien accentuent la détérioration dans le cas où les surfaces se trouvent déjà endommagées.
- Ne pas mélanger les produits d'entretien ensemble. Les réactions chimiques peuvent émettre des gaz toxiques.
- Ne pas utiliser d'éponges métalliques agressives ni de produits d'entretien abrasifs.
- Sous aucun prétexte il ne faut utiliser d'eau de javel à blanchir avec du chlore pour nettoyer ces superficies.
- Il faut seulement utiliser les produits d'entretien expressément indiqués par les fabricants pour chaque type de superficie et de finition.

#### RECOMMANDATIONS POUR L'ENTRETIEN ET LA CONSERVATION DES ROBINETTERIES ET DES ACCESSOIRES

- Lire avant tout la notice du fabricant.
- L'entretien régulier réduira la formation de calcaire et de saletés.
- Les produits d'entretien ne doivent pas s'utiliser plus longtemps que le temps recommandé.
- Si on utilise des produits d'entretien avec pulvérisateur, ne pas l'appliquer directement sur la robinetterie ou les accessoires mais sur un chiffon ou une éponge. Le liquide pulvérisé pourrait s'introduire dans les creux et les fentes de la robinetterie et des accessoires, pouvant causer des dommages irréversibles.
- Si la robinetterie goutte, elle peut causer des tâches de calcaire. Il faut s'assurer que la robinetterie soit fermée correctement après chaque usage.
- Si nécessaire, vous pouvez utiliser votre produit anti-calcaire habituel, mais lisez d'abord la notice du fabricant et après usage, rincez toujours la robinetterie à l'eau claire.
- Pour protéger le mécanisme interne de la robinetterie et allonger la vie utile de cette-ci, Noken recommande l'installation de robinets d'arrêt avec le filtre.

#### CLAUSE DE LA GARANTIE

Ne pas respecter les indications d'entretien peut avoir comme conséquence l'invalidation de la garantie.

## TORNEIRAS E ACESSÓRIOS

Em primeiro lugar, obrigado pela compra de produtos Noken. Na Noken Todos os produtos são feitos com a confiança necessária para dar um serviço de confiança por muitos anos. Como outros produtos de fabricantes acessórios também precisam de cuidados e manutenção adequada para garantir que a sua casa de banho apresente um aspecto impecável

### SUPERFÍCIE DAS TORNEIRAS

De acordo com os requisitos da norma DIN EN 248 camada protetora que é MAIS COMUM utilizar para a fabricação de acessórios incluem metais como cromo, níquel, aço e latão, bem como outros para evitar a humidade. Antes de proceder à limpeza é necessário examinar exactamente o tipo de superfície a ser limpa.

#### LIMPEZA

Para a limpeza de torneiras e acessórios deve-se ter em atenção:

- Apesar de terem sido utilizadas apenas uma vez, todos os produtos que contêm fósforo, clorídrico, muriático, ácido fórmico ou ácido acético, uma vez que podem causar danos consideráveis não devem ser usados. Use um PH neutro.
- Embora os funcionários foram uma vez, qualquer produto que contenha fosfórico, clorídrico, muriático, ácido fórmico ou acético, pois podem causar danos consideráveis não deve ser usado. Use um PH neutro.
- Seque os artigos depois de cada sessão de limpeza e depois de cada utilização para evitar a acumulação de calcário.

#### ATENÇÃO

- Produtos de limpeza acentuam a deterioração se as superfícies já estão danificadas.
- Não misture produtos de limpeza, as reações químicas podem emitir gases tóxicos.
- Não utilize esfregões abrasivos ou produtos de limpeza abrasivos.
- Sob nenhuma circunstância deve ser usado para limpar essas superfícies Lixívia.
- Deve-se utilizar unicamente produtos de limpeza expressamente indicados pelo fabricante para cada tipo de superfície e acabamento.

#### RECOMENDAÇÕES PARA LIMPEZA E CONSERVAÇÃO DE TORNEIRAS E ACESSÓRIOS

- Leia as instruções do fabricante em primeiro lugar.
- A limpeza regular irá reduzir o calcário e sujidade.
- Produtos de limpeza não devem ser utilizados mais do que o necessário.
- Se usar um spray de limpeza, não pulverize diretamente na torneira e acessórios, aplicar num pano ou esponja. O spray líquido pode-se introduzir através dos furos e ranhuras dos equipamentos e pode causar danos irreversíveis.
- Em caso de vazamento de torneira pode causar manchas e placas de calcário, por favor, certifique-se que está bem fechada.
- Se necessário, pode utilizar o produto de limpeza anti-calcário usual, mas devem-se ler as instruções do fabricante em primeiro lugar e só depois utilizar, lavar sempre a torneira com água limpa.
- Para proteger a mecânica da torneira e prolongar a vida útil da mesma, Noken recomenda a instalação de válvulas com filtros.

#### Cláusula relativa à GARANTIA

Não seguir as instruções de manutenção pode resultar na anulação da sua garantia.





---

---

---

---

---

---

---

---

---

---

---

---

---

---

---

---

---

---

---

---

---

---

---

---

---





www.divapoor.com



PORCELANOSA BATHROOMS



[www.noken.com](http://www.noken.com)

Para consultar la garantía u otra información relativa a este producto, visitar nuestra web:  
For a warranty or other information on this product, visit our Web address:  
Pour obtenir une garantie ou d'autres informations sur ce produit, visitez notre site web  
Para garantia ou outras informações sobre este produto, visite o nosso site

