



Sink - CL.1

Lavatory spout, deck-mounted without drain - Chrome

Article number: 13 717 705-00

Date of manufacture from 7/1/2021

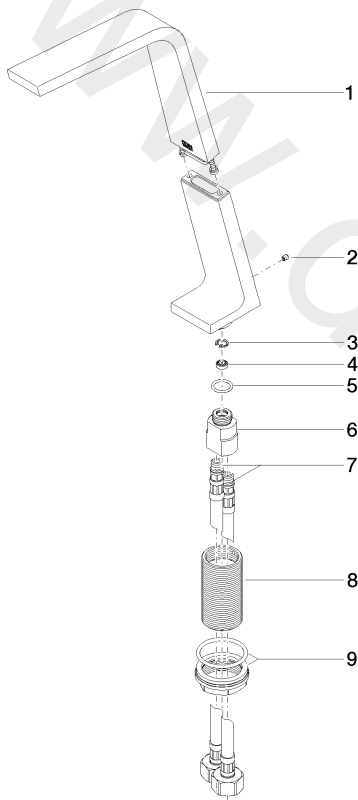



Sink - CL.1

Lavatory spout, deck-mounted without drain - Chrome

Article number: 13 717 705-00

Date of manufacture from 7/1/2021

Spare parts list

Position	Number of units	Item Number	Spare part	Lead time
1	1	90 11 70 003 00-00	spout	10
2	1	09 31 11 044 90	pin	2
3	1	09 16 01 016 90	ring	2
4	1	09 23 01 034 90	flow reducer	2
5	1	09 14 10 130 90	seal	2
6	1	09 11 10 055 10 90	connection	2
7	2	04 30 04 019 00 90	hose	2
8	1	09 30 01 208 90	connection	2
9	1	04 23 10 044 06 90	fixing set	2