

Shower - CL.1

Wall valve clockwise closing 3/4"

Article number: 36 608 705-06

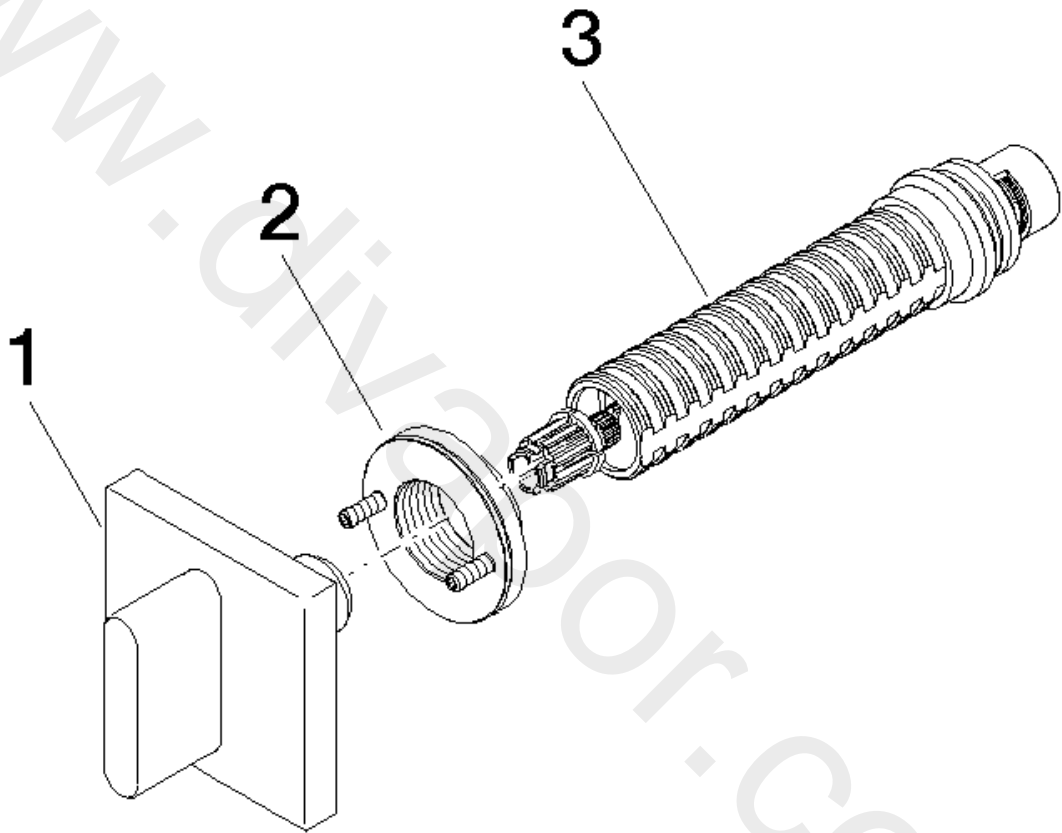

### Spare parts list

Position	Quantity used	Item Number	Spare part	Delivery time
1	1	90 20 70 051 01-06	handle	10
2	1	90 21 02 108 00 90	disc	2
3	1	90 90 03 127 00 90	top	2



Shower - CL.1

Wall valve clockwise closing 3/4"

Article number: 36 608 705-06

[www.divapor.com](http://www.divapor.com)