





Wall valve clockwise closing 3/4"

CL.1

36 608 705

- rosette 60 x 60 mm
- without marking
- head part with cut-to-length spindle and sleeve



	Brushed Platinum	36 608 705-06
	Chrome	36 608 705-00
	Dark Chrome	36 608 705-19
	Brushed Dark Platinum	36 608 705-99

Required miscellaneous



- Wall valve 3/4"** 35 608 970 90
- min. recess depth 105 mm
 - max. recess depth 150 mm

36 608 705

mm [inches]

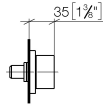
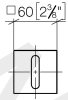

www.divapor.com

36 608 705

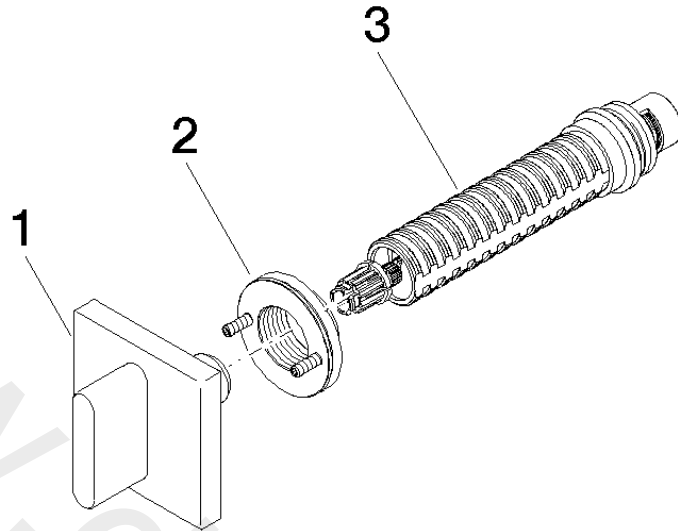

Spare parts list

No.	Item Number	Name	Quantity used	Delivery time
1	90 20 70 051 01-06	handle	1	10
2	90 21 02 108 00 90	disc	1	2
3	90 90 03 127 00 90	top	1	2