

AXOR

DE / Gebrauchsanleitung / Montageanleitung	02
FR / Mode d'emploi / Instructions de montage	02
EN / Instructions for use / assembly instructions	03
IT / Istruzioni per l'uso / Istruzioni per Installazione	03
ES / Modo de empleo / Instrucciones de montaje	04
NL / Gebruiksaanwijzing / Handleiding	04
DK / Brugsanvisning / Monteringsvejledning	05
PT / Instruções para uso / Manual de Instalação	05
PL / Instrukcja obsługi / Instrukcja montażu	06
CS / Návod k použití / Montážní návod	06
SK / Návod na použitie / Montážny návod	07
ZH / 用户手册 / 组装说明	07
RU / Руководство пользователя / Инструкция по монтажу	08
HU / Használati útmutató / Szerelési útmutató	08
FI / Käyttöohje / Asennusohje	09
SV / Bruksanvisning / Monteringsanvisning	09
LT / Vartotojo instrukcija / Montavimo instrukcijos	10
HR / Upute za uporabu / Uputstva za instalaciju	10
TR / Kullanım kılavuzu / Montaj kılavuzu	11
RO / Manual de utilizare / Instrucțiuni de montare	11
EL / Οδηγίες χρήσης / Οδηγία συναρμολόγησης	12
SL / Navodilo za uporabo / Navodila za montažo	12
ET / Kasutusjuhend / Paigaldusjuhend	13
LV / Lietošanas pamācība / Montāžas instrukcija	13
SR / Uputstvo za upotrebu / Uputstvo za montažu	14
NO / Bruksanvisning / Montasjeveiledning	14
BG / Инструкция за употреба / Ръководство за монтаж	15
SQ / Udhëzuesi i përdorimit / Udhëzime rreth montimit	15
AR / دليل الاستخدام / تعليمات التجميع	16

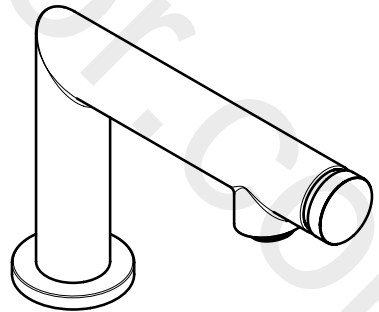

AXOR Uno
45130XXX

△ SICHERHEITSHINWEISE

- △ Bei der Montage müssen zur Vermeidung von Quetsch- und Schnittverletzungen Handschuhe getragen werden.
- △ Das Produkt darf nur zu Bade-, Hygiene- und Körperreinigungszwecken eingesetzt werden.

MONTAGEHINWEISE

- / Vor der Montage muss das Produkt auf Transportschäden untersucht werden. Nach dem Einbau werden keine Transport- oder Oberflächenschäden anerkannt.
- / Die Leitungen und die Armatur müssen nach den gültigen Normen montiert, gespült und geprüft werden.
- / Die in den Ländern jeweils gültigen Installationsrichtlinien sind einzuhalten.

TECHNISCHE DATEN

Armatur serienmäßig mit EcoSmart® (Durchflussbegrenzer)
 Betriebsdruck: max. 1 MPa
 Empfohlener Betriebsdruck: 0,1 - 0,5 MPa
 Prüfdruck: 1,6 MPa
 (1 MPa = 10 bar = 147 PSI)

Das Produkt ist ausschließlich für Trinkwasser konzipiert!

SYMBOLERKLÄRUNG

Kein essigsäurehaltiges Silikon verwenden!



MASSE
(siehe Seite 18)



DURCHFLUSSDIAGRAMM
(siehe Seite 18)



SERVICETEILE
(siehe Seite 21)
 XXX = Farbcodierung
 000 = chrom
 820 = brushed nickel
 930 = Polished Brass



REINIGUNG
(siehe Seite 20)



BEDIENUNG
(siehe Seite 19)



PRÜFZEICHEN
(siehe Seite 19)

MONTAGE (siehe Seite 17)

△ CONSIGNES DE SÉCURITÉ

- △ Lors du montage, porter des gants de protection pour éviter toute blessure par écrasement ou coupure.
- △ Le produit ne doit servir qu'à se laver et à assurer l'hygiène corporelle.

INSTRUCTIONS POUR LE MONTAGE

- / Avant son montage, s'assurer que le produit n'a subi aucun dommage pendant le transport. Après le montage, tout dommage de transport ou de surface ne pourra pas être reconnu.
- / Les conduites et la robinetterie doivent être montés, rincés et contrôlés selon les normes en vigueur.
- / Les directives d'installation en vigueur dans le pays concerné doivent être respectées.

INFORMATIONS TECHNIQUES

Robinetterie équipée en série d'un EcoSmart® (limiteur de débit)
 Pression de service autorisée: max. 1 MPa
 Pression de service conseillée: 0,1 - 0,5 MPa
 Pression maximum de contrôle: 1,6 MPa
 (1 MPa = 10 bar = 147 PSI)

Le produit est exclusivement conçu pour de l'eau potable!

DESCRIPTION DU SYMBOLE

Ne pas utiliser de silicone contenant de l'acide acétique!



DIMENSIONS
(voir pages 18)



DIAGRAMME DU DÉBIT
(voir pages 18)



PIÈCES DÉTACHÉES
(voir pages 21)
 XXX = Couleurs
 000 = chromé
 820 = brushed nickel
 930 = Polished Brass



NETTOYAGE
(voir pages 20)



INSTRUCTIONS DE SERVICE
(voir pages 19)



CLASSIFICATION ACOUSTIQUE ET DÉBIT (voir pages 19)

MONTAGE (voir pages 17)

⚠ SAFETY NOTES

- ⚠ Gloves should be worn during installation to prevent crushing and cutting injuries.
- ⚠ The product may only be used for bathing, hygienic and body cleaning purposes.

INSTALLATION INSTRUCTIONS

- / Prior to installation, inspect the product for transport damages. After it has been installed, no transport or surface damage will be honoured.
- / The pipes and the fixture must be installed, flushed and tested as per the applicable standards.
- / The plumbing codes applicable in the respective countries must be observed.

TECHNICAL DATA

This mixer series-produced with EcoSmart® (flow limiter)

Operating pressure:	max. 1 MPa
Recommended operating pressure:	0,1 - 0,5 MPa
Test pressure:	1,6 MPa
	(1 MPa = 10 bar = 147 PSI)

The product is exclusively designed for drinking water!

⚠ INDICAZIONI SULLA SICUREZZA

- ⚠ Durante il montaggio, per evitare ferite da schiacciamento e da taglio bisogna indossare guanti protettivi.
- ⚠ Il prodotto deve essere utilizzato esclusivamente per fare il bagno e per l'igiene del corpo.

ISTRUZIONI PER IL MONTAGGIO

- / Prima del montaggio è necessario controllare che non ci siano stati danni durante il trasporto. Una volta eseguito il montaggio, non verranno riconosciuti eventuali danni di trasporto o delle superfici.
- / Montare, lavare e controllare tubature e rubinetteria rispettando le norme correnti.
- / Vanno rispettate le direttive di installazione nazionali vigenti nel rispettivo paese.

DATI TECNICI

Questo miscelatore è dotato di serie del EcoSmart® (limitatore di flusso)	
Pressione d'uso:	max. 1 MPa
Pressione d'uso consigliata:	0,1 - 0,5 MPa
Pressione di prova:	1,6 MPa
	(1 MPa = 10 bar = 147 PSI)

Il prodotto è concepito esclusivamente per acqua potabile!

SYMBOL DESCRIPTION

 Do not use silicone containing acetic acid!

 DIMENSIONS
(see page 18)

 FLOW DIAGRAM
(see page 18)

 SPARE PARTS
(see page 21)
XXX = Colors
000 = chrome plated
820 = brushed nickel
930 = Polished Brass

 CLEANING
(see page 20)

 OPERATION
(see page 19)

 TEST CERTIFICATE
(see page 19)

DESCRIZIONE SIMBOLO

 Non utilizzare silicone contenente acido acetico!

 INGOMBRI
(vedi pagg. 18)

 DIAGRAMMA FLUSSO
(vedi pagg. 18)

 PARTI DI RICAMBIO
(vedi pagg. 21)
XXX = Trattamento
000 = cromato
820 = brushed nickel
930 = Polished Brass

 PULITURA
(vedi pagg. 20)

 PROCEDURA
(vedi pagg. 19)

 SEGNO DI VERIFICA
(vedi pagg. 19)

ASSEMBLY (see page 17) 

MONTAGGIO (vedi pagg. 17) 

△ INDICACIONES DE SEGURIDAD

- △ Durante el montaje deben utilizarse guantes para evitar heridas por aplastamiento o corte.
- △ El producto solo debe ser utilizado para fines de baño, higiene y limpieza corporal.

INDICACIONES PARA EL MONTAJE

- / Antes del montaje se debe examinar el producto contra daños de transporte. Después de la instalación no se reconoce ningún daño de transporte o de superficie.
- / Los conductos y la grifería deben montarse, lavarse y comprobarse según las normas vigentes.
- / Es obligatorio el cumplimiento de las directrices de instalación vigentes en el país respectivo.

DATOS TÉCNICOS

Grifo, desde fábrica equipado con EcoSmart® (limitador de caudal)

Presión en servicio: max. 1 MPa

Presión recomendada en servicio: 0,1 - 0,5 MPa

Presión de prueba: 1,6 MPa

(1 MPa = 10 bar = 147 PSI)

El producto ha sido concebido exclusivamente para agua potable.

DESCRIPCIÓN DE SÍMBOLOS

No utilizar silicona que contiene ácido acético



DIMENSIONES

(ver página 18)



DIAGRAMA DE CIRCULACIÓN

(ver página 18)



REPUESTOS

(ver página 21)

XXX = Acabados

000 = cromado

820 = brushed nickel

930 = Polished Brass



LIMPIAR

(ver página 20)



MANEJO

(ver página 19)



MARCA DE VERIFICACIÓN

(ver página 19)

MONTAJE (ver página 17) 

△ VEILIGHEIDSINSTRUCTIES

- △ Bij de montage moeten ter voorkoming van knel- en snijwonden handschoenen worden gedragen.
- △ Het product mag alleen voor het wassen, hygiënische doeleinden en voor de lichaamreiniging worden gebruikt.

MONTAGE-INSTRUCTIES

- / Vóór de montage moet het product gecontroleerd worden op transportschade. Na de inbouw wordt geen transport- of oppervlakteschade meer aanvaard.
- / De leidingen en armaturen moeten gemonteerd, gespoeld en gecontroleerd worden volgens de geldige normen.
- / De in de overeenkomstige landen geldende installatierichtlijnen moeten nageleefd worden.

TECHNISCHE GEGEVENEN

Armatuur standaard met EcoSmart® (doorstroombegrenzer)

Werkdruk: max. max. 1 MPa

Aanbevolen werkdruk: 0,1 - 0,5 MPa

Getest bij: 1,6 MPa

(1 MPa = 10 bar = 147 PSI)

Het product is uitsluitend ontworpen voor drinkwater!

SYMBOOLBESCHRIJVING

Gebruik geen zuurhoudende siliconen!



MATEN

(zie blz. 18)



DOORSTROOMDIAGRAM

(zie blz. 18)



SERVICE ONDERDELEN

(zie blz. 21)

XXX = Kleuren

000 = verchromd

820 = brushed nickel

930 = Polished Brass



REINIGEN

(zie blz. 20)



BEDIENING

(zie blz. 19)



KEURMERK

(zie blz. 19)

MONTAGE (zie blz. 17) 

△ SIKKERHEDSANVISNINGER

- △ Ved monteringen skal der bruges handsker for at undgå kvæstelser og snitsår.
- △ Produktet må kun bruges til bade-, hygiejne og kropsrengøringsformål.

MONTERINGSANVISNINGER

- / Før monteringen skal produktet kontrolleres for transportskader. Efter monteringen godkendes transportskader eller skader på overfladen ikke længere.
- / Ledningerne og armaturerne skal monteres, skylles og kontrolleres iht. de gældende standarder.
- / Installationsbestemmelserne, der gælder i det enkelte land, skal overholdes.

TEKNISKE DATA

Armaturet er forsynet med EcoSmart® (gennemstrømningsbegrænser)

Driftstryk:	max. 1 MPa
Anbefalet driftstryk:	0,1 - 0,5 MPa
Prøvetryk:	1,6 MPa
	(1 MPa = 10 bar = 147 PSI)

Produktet er udelukkende beregnet til drikkevand!

SYMBOLBESKRIVELSE



Der må ikke benyttes eddikesyreholdig silikone!



MÅLENE
(se s. 18)



GENNEMSTRØMNINGSDIAGRAM
(se s. 18)



RESERVEDELE

(se s. 21)
XXX = Overflade
000 = Krom
820 = Brushed nickel
930 = Polished Brass



RENGØRING
(se s. 20)



BRUGSANVISNING
(se s. 19)



GODKENDELSE
(se s. 19)

MONTERING (se s. 17)

△ AVISOS DE SEGURANÇA

- △ Durante a montagem devem ser utilizadas luvas de protecção, de modo a evitar ferimentos resultantes de entalamentos e de cortes.
- △ O produto só pode ser utilizado para fins de higiene pessoal.

AVISOS DE MONTAGEM

- / Antes da montagem deve-se controlar o produto relativamente a danos de transporte. Após a montagem não são aceites quaisquer danos de transporte ou de superfície.
- / As tubagens e a torneira têm que ser montadas, enxaguadas e verificadas de acordo com as normas em vigor.
- / A prescrições de instalação válidas nos respetivos países devem ser respeitadas.

DADOS TÉCNICOS

Misturadoras produzidas em série com EcoSmart® (limitador de caudal)	
Pressão de funcionamento:	max. 1 MPa
Pressão de func. recomendada:	0,1 - 0,5 MPa
Pressão testada:	1,6 MPa
	(1 MPa = 10 bar = 147 PSI)

Este produto foi única e exclusivamente concebido para água potável!

DESCRIÇÃO DO SÍMBOLO



Não utilizar silicone que contenha ácido acético!



MEDIDAS
(ver página 18)



FLUXOGRAMA
(ver página 18)



PEÇAS DE SUBSTITUIÇÃO

(ver página 21)
XXX = Acabamentos
000 = cromado
820 = brushed nickel
930 = Polished Brass



LIMPEZA
(ver página 20)



FUNCIONAMENTO
(ver página 19)



MARCA DE CONTROLO
(ver página 19)

MONTAGEM (ver página 17)

△ WSKAZÓWKI BEZPIECZEŃSTWA

- △ Aby uniknąć zranień na skutek zgniecenia lub przecięcia, podczas montażu należy nosić rękawice ochronne.
- △ Produkt może być używany tylko do kąpieli, higieny i czyszczenia ciała.

WSKAZÓWKI MONTAŻOWE

- / Przed montażem należy skontrolować produkt pod kątem szkód transportowych. Po montażu nie widać żadnych szkód transportowych ani szkód na powierzchni.
- / Przewody i armatura muszą być montowane, płukane i kontrolowane według obowiązujących norm.
- / Należy przestrzegać wytycznych instalacyjnych obowiązujących w danym kraju.

DANE TECHNICZNE

Armatura produkowana seryjnie z funkcją EcoSmart® (ogranicznik przepływu)

Ciśnienie robocze:	maks. 1 MPa
Zalecane ciśnienie robocze:	0,1 - 0,5 MPa
Ciśnienie próbne:	1,6 MPa
	(1 MPa = 10 bary = 147 PSI)

Produkt przeznaczony wyłącznie do wody pitnej!

OPIS SYMBOLU



Nie stosować silikonów zawierających kwas octowy!



WYMIARY
(patrz strona 18)



SCHEMAT PRZEPŁYWU
(patrz strona 18)



CZĘŚCI SERWISOWE
(patrz strona 21)
XXX = Kody kolorów
000 = chrom
820 = nikiel szorowany
930 = Polished Brass



CZYSZCZENIE
(patrz strona 20)



OBŚŁUGA
(patrz strona 19)



ZNAK JAKOŚCI
(patrz strona 19)

MONTAŻ (patrz strona 17) 

△ BEZPEČNOSTNÍ POKYNY

- △ Pro zabránění řezným zraněním a pohmožděninám je nutné při montáži nosit rukavice.
- △ Produkt smí být používán pouze ke koupání a za účelem tělesné hygieny.

POKYNY K MONTÁŽI

- / Před montáží je třeba produkt zkontrolovat, zda nebyl při transportu poškozen. Po zabudování nebudou uznány žádné škody způsobené transportem nebo poškození povrchu.
- / Vedení a armatura musí být namontovány, propláchnuty a otestovány podle platných norem.
- / Je třeba dodržovat montážní pravidla platná v dané zemi.

TECHNICKÉ ÚDAJE

Armatura je sériově vybavena zařízením EcoSmart® (omezovač průtoku)

Provozní tlak:	max. 1 MPa
Doporučený provozní tlak:	0,1 - 0,5 MPa
Zkušební tlak:	1,6 MPa
	(1 MPa = 10 bar = 147 PSI)

Výrobky Hansgrohe jsou vhodné pro přímý kontakt s pitnou vodou.

POPIS SYMBOLŮ



Nepoužívat silikon s obsahem kyseliny octové!



ROZMĚRY
(viz strana 18)



DIAGRAM PRŮTOKU
(viz strana 18)



SERVISNÍ DÍLY
(viz strana 21)
XXX = Kód povrchové úpravy
000 = chrom
820 = brushed nickel
930 = Polished Brass



ČIŠTĚNÍ
(viz strana 20)



OVĚŘENÍ
(viz strana 19)



ZKUŠEBNÍ ZNAČKA
(viz strana 19)

MONTÁŽ (viz strana 17) 

△ BEZPEČNOSTNÉ POKYNY

- △ Pri montáži musíte nosiť rukavice, aby ste predišli pomliaždeninám a rezným poraneniam.
- △ Produkt sa smie používať len na kúpanie a telesnú hygienu.

POKYNY PRE MONTÁŽ

- / Pred montážou musíte produkt skontrolovať, či nebol počas transportu poškodený. Po zabudovaní nebudú uznané žiadne škody spôsobené transportom alebo poškodenia povrchu.
- / Ledningarna och blandaren måste monteras, spolat igenom och kontrolleras enligt de gällande normerna.
- / Je potrebné dodržiavať smernice o inštalácii, ktoré sú práve teraz platné v krajinách.

TECHNICKÉ ÚDAJE

Armatura je sériovo vybavená zariadením EcoSmart® (obmedzovač prietoku)

Prevádzkový tlak: max. 1 MPa

Doporučený prevádzkový tlak: 0,1 - 0,5 MPa

Skúšobný tlak: 1,6 MPa

(1 MPa = 10 bar = 147 PSI)

Výrobok je koncipovaný výhradne pre pitnú vodu!

POPIS SYMBOLOV



Nepoužívať silikón s obsahom kyseliny octovej!



ROZMERY
(viď strana 18)



DIAGRAM PRIETOKU
(viď strana 18)



SERVISNÉ DIELY

(viď strana 21)

XXX = Farebné označenie

000 = chróm

820 = brushed nickel

930 = Polished Brass



ČISTENIE
(viď strana 20)



OBSLUHA
(viď strana 19)



OSVEDČENIE O SKÚŠKE
(viď strana 19)

MONTÁŽ (viď strana 17)

△ 安全技巧

- △ 装配时为避免挤压和切割受伤，必须戴上手套。
- △ 本产品只允许作为洗浴、卫生和洁身之用。

安装提示

- / 安装前必须检查产品是否受到运输损害。安装后将不认可运输损害或表面损伤。
- / 管道和阀门必须根据通用标准进行安装、冲洗和检查。
- / 请遵守当地国家现行的安装规定。

技术参数

本龙头配有 EcoSmart® (流量限制器)

工作压力: 最大 1 MPa

推荐工作压力: 0,1 - 0,5 MPa

测试压强: 1,6 MPa

(1 MPa = 10 bar = 147 PSI)

该产品专为饮用水设计!

符号说明



请勿使用含有乙酸的硅胶!



大小
(参见第 18)



流量示意图
(参见第 18)



备用零件

(参见第 21)

XXX = 颜色代码

000 = 镀铬

820 = 镍拉丝

930 = Polished Brass



清洗
(参见第 20)



操作
(参见第 19)



检验标记
(参见第 19)

安装 (参见第 17)

△ УКАЗАНИЯ ПО ТЕХНИКЕ БЕЗОПАСНОСТИ

- △ Во время монтажа следует надеть перчатки во избежание прищемления и порезов.
- △ Изделие разрешается использовать только в гигиенических целях: для принятия ванны и личной гигиены.

УКАЗАНИЯ ПО МОНТАЖУ

- / Перед монтажом следует проверить изделие на предмет повреждений при перевозке. После монтажа претензии о возмещении ущерба за повреждения при перевозке или повреждения поверхностей не принимаются.
- / Трубы и арматура должны быть установлены, промыты и проверены в соответствии с действующими нормами.
- / Необходимо соблюдать требования по монтажу, действующие в соответствующих странах.

ТЕХНИЧЕСКИЕ ДАННЫЕ

Смесители этой серии серийно оснащаются EcoSmart® (ограничителем потока воды)
 Рабочее давление: не более 1 МПа
 Рекомендуемое рабочее давление: 0,1 - 0,5 МПа
 Давлении: 1,6 МПа
 (1 МПа = 10 bar = 147 PSI)

Изделие предназначено исключительно для питьевой воды!

ОПИСАНИЕ СИМВОЛОВ



Не применяйте силикон, содержащий уксусную кислоту.



РАЗМЕРЫ
(см. стр. 18)



СХЕМА ПОТОКА
(см. стр. 18)



КОМПЛЕКТ
(см. стр. 21)
 XXX = Цветная кодировка
 000 = хром
 820 = brushed nickel
 930 = Polished Brass



ОЧИСТКА
(см. стр. 20)



ЭКСПЛУАТАЦИЯ
(см. стр. 19)



ЗНАК ТЕХНИЧЕСКОГО КОНТРОЛЯ (см. стр. 19)

МОНТАЖ (см. стр. 17) 

△ BIZTONSÁGI UTASÍTÁSOK

- △ A szerelésnél a zúzódások és vágási sérülések elkerülése érdekében kesztyűt kell viselni.
- △ A terméket csak fürdéshez, mosakodáshoz, és egészségügyi tisztálkodáshoz szabad használni.

SZERELÉSI UTASÍTÁSOK

- / A szerelés előtt ellenőrizni kell, hogy a terméknek nincs-e szállítási sérülése. Beépítés után a szállítási- vagy felületi sérüléseket nem ismerik el.
- / A vezetékeket és a csaptelepet az érvényes szabványoknak megfelelően kell felszerelni, öblíteni és ellenőrizni
- / Az egyes országokban érvényes installációs irányelveket kell tartani.

MŰSZAKI ADATOK

A csaptelep szériakivitelben el van látva EcoSmart® (átfolyáskorlátozó) berendezéssel

Üzemi nyomás: max. 1 MPa
 Ajánlott üzemi nyomás: 0,1 - 0,5 MPa
 Nyomáspróba: 1,6 MPa
 (1 MPa = 10 bar = 147 PSI)

A terméket kizárólag ivóvízhez tervezték!

SZIMBÓLUMOK LEÍRÁSA



Ne használjon ecetsavtartalmú szilikont!



MÉRETET
(lásd a oldalon 18)



ÁTFOLYÁSI DIAGRAMM
(lásd a oldalon 18)



TARTOZÉKOK
(lásd a oldalon 21)
 XXX = Színkódolás
 000 = króm
 820 = brushed nickel
 930 = Polished Brass



TISZTÍTÁS
(lásd a oldalon 20)



HASZNÁLAT
(lásd a oldalon 19)



VIZSGAJEL
(lásd a oldalon 19)

SZERELÉS (lásd a oldalon 17) 

△ TURVALLISUUSOHJEET

- △ Asennuksessa on käytettävä käsineitä puristumien ja viiltojen aiheuttamien tapaturmien estämiseksi.
- △ Tuotetta saa käyttää ainoastaan kylpy-, hygienia- ja puhdistustarkoituksiin.

ASENNUSOHJEET

- / Ennen asennusta on tarkastettava tuotteen mahdolliset kuljetusvahingot. Asennuksen jälkeen kuljetus- ja pintavaurioita ei hyväksytä.
- / Putket ja hana on asennettava, huuhdeltava ja tarkastettava voimassa olevien standardien mukaisesti.
- / Jokaisessa maassa on noudatettava siellä päteviä asennusohjeita.

TEKNISET TIEDOT

Kaluste on vakiona varustettu EcoSmart® (virtauksenrajoittimella)

Käyttöpaine: maks. 1 MPa

Suosittelua käyttöpaine: 0,1 - 0,5 MPa

Koestuspaine: 1,6 MPa

(1 MPa = 10 bar = 147 PSI)

Tuote on suunniteltu käytettäväksi ainoastaan juomaveden kanssa!

MERKIN KUVAUS



Älä käytä etikkahappopitoista silikonial



MITAT
(katso sivu 18)



VIRTAUSDIAGRAMMI
(katso sivu 18)



VARAOSAT
(katso sivu 21)
XXX = Värikoodaus
000 = kromi
820 = harjattu nikkeli
930 = Polished Brass



PUHDISTUS
(katso sivu 20)



KÄYTTÖ
(katso sivu 19)



KOESTUSMERKKI
(katso sivu 19)

ASENNUS (katso sivu 17)

△ SÄKERHETSANVISNINGAR

- △ Handskar ska bäras under monteringsarbetet så att man kan undvika kläm- och skärskadorgen werden.
- △ Produkten får bara användas till kroppshygien med bad och dusch.

MONTERINGSANVISNINGAR

- / Det måste undersökas om produkten har transportskador innan den monteras. Efter monteringen accepteras inga transport- eller ytskiktsskador.
- / Ledningarna och blandaren måste monteras, spolas igenom och kontrolleras enligt de gällande normerna.
- / De installationsriktlinjer som gäller i länderna ska följas.

TEKNISKA DATA

Blandare seriemässigt med EcoSmart® (flödeskontroll)

Driftstryck: max. 1 MPa

Rek. driftstryck: 0,1 - 0,5 MPa

Tryck vid provtryckning: 1,6 MPa

(1 MPa = 10 bar = 147 PSI)

Produkten är enbart avsedd för dricksvatten!

SYMBOLFÖRKLARING



Använd inte silikon som innehåller ättiksyra!



MÅTTEN
(se sidan 18)



FLÖDESSCHEMA
(se sidan 18)



RESERVDELAR
(se sidan 21)
XXX = Färgkodning
000 = krom
820 = borstad nickel
930 = Polished Brass



RENGÖRING
(se sidan 20)



HANTERING
(se sidan 19)



TESTSIGILL
(se sidan 19)

MONTERING (se sidan 17)

SAUGUMO TECHNIKOS NURODYMAI

- ⚠ Apsaugai nuo užspaudimo ir įsijovimo montavimo metu mūvėkite pirštines.
- ⚠ Gaminys turi būti naudojamas tik maudymuisi, kūno higienai ir švarai palaikyti.

MONTAVIMO INSTRUKCIJA

- / Prieš montuojant būtina patikrinti, ar gaminys nebuvo pažeistas transportavimo metu. Sumontavus pretenzijos dėl transportavimo ir paviršiaus pažeidimų nepriimamos.
- / Vamzdžiai ir sujungimai turi būti montuojami, plaunami ir tikrinami pagal galiojančias normas.
- / Laikykites atitinkamoje šalyje galiojančių direktyvų dėl įrengimo.

TECHNINIAI DUOMENYS

Šios serijos maišytuvai turi EcoSmart® (vandens srauto ribotuvą)

Darbinis slėgis: ne daugiau kaip 1 MPa

Rekomenduojamas slėgis: 0,1 - 0,5 MPa

Bandomasis slėgis: 1,6 MPa

(1 MPa = 10 barų = 147 PSI)

Produktas skirtas tik geriamajam vandeniui!

SIMBOLIO APRAŠYMAS



Nenaudokite silikono, kurio sudėtyje yra acto rūgšties!



IŠMATAVIMAI
(žr. psl. 18)



PRALAUDUMO DIAGRAMA
(žr. psl. 18)



ATSARGINĖS DALYS

(žr. psl. 21)

XXX = Spalvos

000 = chrom

820 = brushed nickel

930 = Polished Brass



VALYMAS
(žr. psl. 20)



EKSPLOATACIJA
(žr. psl. 19)



BANDYMO PAŽYMA
(žr. psl. 19)

SIGURNOSNE UPUTE

- ⚠ Prilikom montaže se radi sprječavanja prignječenja i posjekotina moraju nositi rukavice.
- ⚠ Proizvod se smije primijenjivati samo za kupanje, tuširanje i osobnu higijenu.

UPUTE ZA MONTAŽU

- / Prieš montaže mora se provjeriti je li proizvod oštećen prilikom transporta. Nakon ugradnje se ne priznaju nikakve reklamacije koje se odnose na površinska i transportna oštećenja.
- / Cijevi i armatura moraju biti postavljeni, isprani i testirani prema važećim normama.
- / Obvezno se moraju uvažiti propisi o instalacijama koji vrijede u dotičnoj zemlji.

TEHNIČKI PODATCI

Armatura ima serijski ugrađen EcoSmart® (limitator protoka)

Najveći dopušteni tlak: tlak 1 MPa

Preporučeni tlak: 0,1 - 0,5 MPa

Probni tlak: 1,6 MPa

(1 MPa = 10 bar = 147 PSI)

Proizvod je koncipiran isključivo za pitku vodu!

OPIS SIMBOLA



Nemojte koristiti silikon koji sadrži octenu kiselinu!



MJERE
(pogledaj stranicu 18)



DIJAGRAM PROTOKA
(pogledaj stranicu 18)



REZERVNI DJELOVI

(pogledaj stranicu 21)

XXX = Boje

000 = krom

820 = brushed nickel

930 = Polished Brass



ČIŠĆENJE
(pogledaj stranicu 20)



UPOTREBA
(pogledaj stranicu 19)



OZNAKA TESTIRANJA
(pogledaj stranicu 19)

⚠ GÜVENLİK UYARILARI

- ⚠ Montaj esnasında ezilme ve kesilme gibi yaralanmaları önlemek için eldiven kullanılmalıdır.
- ⚠ Ürün yalnızca banyo, hijyen ve beden temizliği amaçları doğrultusunda kullanılabilir.

MONTAJ AÇIKLAMALARI

- / Montaj işleminden önce ürün nakliye hasarları yönünden kontrol edilmelidir. Montaj işleminden sonra nakliye veya yüzey hasarları için sorumluluk üstlenilmemektedir.
- / Boruların ve armatürün montajı, yıkanması ve kontrolü geçerli normlara göre yapılmalıdır.
- / Ülkelerde geçerli kurulum yönetmeliklerine riayet edilmelidir.

TEKNİK BİLGİLER

Batarya EcoSmart® (akış sınırlayıcısı) ile birlikte seri olarak işletme basıncı: azami 1 MPa
Tavsiye edilen işletme basıncı: 0,1 - 0,5 MPa
Kontrol basıncı: 1,6 MPa
(1 MPa = 10 bar = 147 PSI)

Ürün sadece şebeke suyu için tasarlanmıştır!

⚠ INSTRUCȚIUNI DE SIGURANȚĂ

- ⚠ La montare utilizați mănuși pentru evitarea contuziunilor și tăierii mâinilor.
- ⚠ Produsul poate fi utilizat doar pentru spălarea, menținerea igienei și curățarea corpului.

INSTRUCȚIUNI DE MONTARE

- / Înainte de instalare verificați, dacă produsul prezintă deteriorări de transport. După instalare garanția nu acoperă deteriorările de transport și cele de suprafață.
- / Conductele și bateriile trebuie montate, spălate și verificate conform normelor în vigoare.
- / Respectați reglementările referitoare la instalare valabile în țara respectivă.

DATE TEHNICE

Bateria este dotată în serie cu EcoSmart® (limitator de debit)
Presiune de funcționare: max. 1 MPa
Presiune de funcționare recomandată: 0,1 - 0,5 MPa
Presiune de verificare: 1,6 MPa
(1 MPa = 10 bar = 147 PSI)
Produsul este destinat exclusiv pentru apă potabilă.

SİMGE AÇIKLAMASI

 Asetik asit içeren silikon kullanmayın!

 ÖLÇÜLERİ
(bakınız sayfa 18)

 AKIŞ DİYAGRAMI
(bakınız sayfa 18)

 YEDEK PARÇALAR
(bakınız sayfa 21)
XXX = Renkler
000 = krom
820 = brushed nickel
930 = Polished Brass

 TEMİZLEME
(bakınız sayfa 20)

 KULLANIMI
(bakınız sayfa 19)

 KONTROL İŞARETİ
(bakınız sayfa 19)

MONTAJI (bakınız sayfa 17) 

DESCRIEREA SIMBOLURILOR

 Nu utilizați silicon cu conținut de acid acetic!

 DIMENSIUNI
(vezi pag. 18)

 DIAGRAMA DE DEBIT
(vezi pag. 18)

 PIESE DE SCHIMB
(vezi pag. 21)
XXX = Coduri de culori
000 = crom
820 = nichel mat
930 = Polished Brass

 CURĂȚARE
(vezi pag. 20)

 UTILIZARE
(vezi pag. 19)

 CERTIFICAT DE TESTARE
(vezi pag. 19)

MONTARE (vezi pag. 17) 

⚠ ΥΠΟΔΕΙΞΕΙΣ ΑΣΦΑΛΕΙΑΣ

- ⚠ Για να αποφύγετε τραυματισμούς κατά τη συναρμολόγηση πρέπει να φοράτε γάντια.
- ⚠ Το προϊόν επιτρέπεται να χρησιμοποιείται μόνο σαν μέσο λουτρού, υγιεινής και καθαρισμού του σώματος.

ΟΔΗΓΙΕΣ ΣΥΝΑΡΜΟΛΟΓΗΣΗΣ

- / Πριν τη συναρμολόγηση πρέπει να εξεταστεί το προϊόν για ζημιές μεταφοράς. Μετά την εγκατάσταση δεν αναγνωρίζονται ζημιές από τη μεταφορά ή επιφανειακές ζημιές.
- / Οι σωλήνες και η μπαταρία πρέπει να τοποθετηθούν σύμφωνα με τα ισχύοντα πρότυπα, να τεθούν υπό πίεση και να δοκιμαστούν.
- / Θα πρέπει να τηρούνται οι οδηγίες εγκατάστασης που ισχύουν σε κάθε κράτος.

ΤΕΧΝΙΚΑ ΧΑΡΑΚΤΗΡΙΣΤΙΚΑ

Μπαταρία μόνιμα εξοπλισμένη με EcoSmart® (μειωτής ροής)

Λειτουργία πίεσης: έως 1 MPa

Συνιστώμενη λειτουργία πίεσης: 0,1 - 0,5 MPa

Πίεση ελέγχου: 1,6 MPa

(1 MPa = 10 bar = 147 PSI)

Το προϊόν έχει σχεδιαστεί αποκλειστικά για πόσιμο νερό!

ΠΕΡΙΓΡΑΦΗ ΣΥΜΒΟΛΩΝ

Μην χρησιμοποιείτε σιλικόνη που περιέχει οξικό οξύ!



ΔΙΑΣΤΑΣΕΙΣ
(βλ. Σελίδα 18)



ΔΙΑΓΡΑΜΜΑ ΡΟΗΣ
(βλ. Σελίδα 18)



ΑΝΤΑΛΛΑΚΤΙΚΑ
(βλ. Σελίδα 21)
XXX = Χρώματα
000 = Επιχρωμιωμένο
820 = νικελ ματ
930 = Polished Brass



ΚΑΘΑΡΙΣΜΟΣ
(βλ. Σελίδα 20)



ΧΕΙΡΙΣΜΟΣ
(βλ. Σελίδα 19)



ΣΗΜΑ ΕΛΕΓΧΟΥ
(βλ. Σελίδα 19)

ΣΥΝΑΡΜΟΛΟΓΗΣΗ (βλ. Σελίδα 17) 

⚠ VARNOSTNA OPOZORILA

- ⚠ Pri montaži je treba nositi rokavice, da se prepreči poškodbe zaradi zmečkanja ali urezov.
- ⚠ Ta izdelek se sme uporabljati le z namenom umivanja, vzdrževanja higiene in telesne nege.

NAVODILA ZA MONTAŽO

- / Pred montažo je treba izdelek preveriti glede morebitnih transportnih poškodb. Po vgradnji transportne ali površinske poškodbe ne bodo več priznane.
- / Cevi in armaturo je treba montirati, izprati in preveriti po veljavnih standardih.
- / Upoštevati je treba pravilnike o inštalacijah, ki veljajo v posamezni državi.

TEHNIČNI PODATKI

Armaturo je serijsko opremljena z EcoSmart® (omejevalnikom pretoka)

Delovni tlak: maks. 1 MPa

Priporočeni delovni tlak: 0,1 - 0,5 MPa

Preskusni tlak: 1,6 MPa

(1 MPa = 10 bar = 147 PSI)

Proizvod je zasnovan izključno za sanitarno vodo!

OPIS SIMBOLA

Ne smete uporabiti silikona, ki vsebuje ocetno kislino!



MERE
(glejte stran 18)



DIAGRAM PRETOKA
(glejte stran 18)



REZERVNI DELI
(glejte stran 21)
XXX = Barve
000 = krom
820 = brushed nickel
930 = Polished Brass



ČIŠČENJE
(glejte stran 20)



UPRAVLJANJE
(glejte stran 19)



PRESKUSNI ZNAK
(glejte stran 19)

MONTAŽA (glejte stran 17) 

△ OHUTUSJUHISED

- △ Kandke paigaldamisel muljumis- ja löikevigastuste vältimiseks kindaid.
- △ Toode tohib kasutada ainult pesemis-, hügieeni- ja kehapuhastamiseemärkidel.

PAIGALDAMISJUHISED

- / Enne paigaldamist tuleb toodet kontrollida transpordikahjustuste osas Pärast paigaldamist ei tunnustata enam transpordi- või pinnakahjustuste kaebuseid.
- / Voolikute ja segisti paigaldamisel, loputamisel ja kontrollimisel tuleb lähtuda kehtivatest normatiividest
- / Vastavas riigis kehtivaid paigalduseeskirju tuleb järgida.

TEHNILISED ANDMED

Segistisari on toodetud koos EcoSmart® (veehulgapiirajaga)

Töörõhk maks. 1 MPa

Soovitatav töörõhk: 0,1 - 0,5 MPa

Kontrollsurve: 1,6 MPa

(1 MPa = 10 baari = 147 PSI)

Toode on ette nähtud eranditult joogivee jaoks!

△ DROŠĪBAS NORĀDES

- △ Montāžas laikā, lai izvairītos no saspiedumiem un iegriezumiem, nepieciešams nēsāt cimdus.
- △ Šo produktu drīkst izmantot tikai, lai mazgātos, higiēnai un ķermeņa tīrīšanai.

NORĀDĪJUMI MONTĀŽAI

- / Pirms montāžas nepieciešams pārbaudīt, vai produktam transportēšanas laikā nav radušies bojājumi. Pēc iebūvēšanas bojājumi, kas radušies transportēšanas laikā, vai virsmas bojājumi netiek atzīti.
- / Caurulvadi un armatūra ir jāuzstāda, jāizskalo un jāpārbauda saskaņā ar spēkā esošajiem standartiem.
- / Jāievēro attiecīgās valstīs spēkā esošās montāžas prasības.

TEHNISKIE DATI

Jaucējkrāns tiek ražots kopā ar EcoSmart® (caurteces ierobežotāju)

Darba spiediens: maks. 1 MPa

leteicamais darba spiediens: 0,1 - 0,5 MPa

Pārbaudes spiediens: 1,6 MPa

(1 MPa = 10 bar = 147 PSI)

Izstrādājums ir paredzēts tikai dzeramajam ūdenim!

SŪMBOLITE KIRJELDUS



Ārge kasutage äädikhapet sisaldavat silikoonil



MÕÕTUDE
(vt lk 18)



LÄBIVOOLUDIAGRAMM
(vt lk 18)



VARUOSAD
(vt lk 21)

XXX = Värvid

000 = kroom

820 = brushed nickel

930 = Polished Brass



PUHASTAMINE
(vt lk 20)



KASUTAMINE
(vt lk 19)



KONTROLLSERTIFIKAAT
(vt lk 19)

SIMBOLU NOZĪME



Neizmantoj silikonu, kas satur etiķskābi!



IZMĒRUS
(skat. lpp. 18)



CAURPLŪDES DIAGRAMMA
(skat. lpp. 18)



REZERVES DAĻAS
(skat. lpp. 21)

XXX = Krāsu kodi

000 = hroma

820 = brushed nickel

930 = Polished Brass



TĪRĪŠANA
(skat. lpp. 20)



LIETOŠANA
(skat. lpp. 19)



PĀRBAUDES ZĪME
(skat. lpp. 19)

PAIGALDAMINE (vt lk 17) 

MONTĀŽA (skat. lpp. 17) 

△ SIGURNOSNE NAPOMENE

- △ Prilikom montaže se radi sprečavanja prignječenja i posekotina moraju nositi rukavice.
- △ Proizvod sme da se koristi samo za kupanje, tuširanje i ličnu higijenu.

INSTRUKCIJE ZA MONTAŽU

- / Pre montaže se mora proveriti da li je proizvod oštećen pri transportu. Nakon ugradnje se ne priznaju nikakve reklamacije koje se odnose na površinska i transportna oštećenja.
- / Vodovi i armatura moraju biti postavljeni, isprani i testirani prema važećim normama.
- / Treba se pridržavati propisa koji u određenim zemljama važe za instalacije.

TEHNIČKI PODACI

Ove armature imaju serijski ugrađen EcoSmart®

(ograničavač protoka vode)

Radni pritisak: maks. 1 MPa

Preporučeni radni pritisak: 0,1 - 0,5 MPa

Probni pritisak: 1,6 MPa

(1 MPa = 10 bar = 147 PSI)

Proizvod je koncipiran isključivo za pijaću vodu!

OPIS SIMBOLA



Nemojte koristiti silikon koji sadrži sirćetnu kiselinu!



MERE

(vidi stranu 18)



DIJAGRAM PROTOKA

(vidi stranu 18)



REZERVNI DELOVI

(vidi stranu 21)

XXX = Oznake boja

000 = hrom

820 = brushed nickel

930 = Polished Brass



ČIŠĆENJE

(vidi stranu 20)



UKOVANJE

(vidi stranu 19)



ISPITNI ZNAK

(vidi stranu 19)

MONTAŽA (vidi stranu 17) 

△ SIKKERHETSHENVISNINGER

- △ Bruk hansker under montasjen for å unngå klem- og kuttskader.
- △ Produktet skal kun brukes for bade-, hygiene- og kroppshygiene.

MONTAGEHENVISNINGER

- / Før montasjen skal produktet sjekkes for transportskader. Etter monteringen aksepteres ikke noen transport- eller overflateskader.
- / Ledningene og armaturen skal monteres, spyles og sjekkes iht. de gyldige normer.
- / Gjeldende retningslinjer for rørleggerarbeid i de enkelte land skal følges.

TEKNISKE DATA

Armatur er standardmessig utstyrt med EcoSmart® (gjennomstrømningsbegrenser)

Driftstrykk maks. 1 MPa

Anbefalt driftstrykk: 0,1 - 0,5 MPa

Prøvetrykk 1,6 MPa

(1 MPa = 10 bar = 147 PSI)

Produktet er utelukkende designet for drikkevann!

SYMBOLBESKRIVELSE



Ikke bruk silikon som inneholder eddiksyre!



MÅL

(se side 18)



GJENNOMSTRØMNINGSDIAGRAM

(se side 18)



SERVICEDELER

(se side 21)

XXX = Fargekode

000 = krom

820 = børstet nikkel

930 = Polished Brass



RENGJØRING

(se side 20)



BETJENING

(se side 19)



PRØVERMERKE

(se side 19)

MONTASJE (se side 17) 

△ УКАЗАНИЯ ЗА БЕЗОПАСНОСТ

- △ При монтажа трябва да се носят ръкавици, за да се избегнат наранявания поради притискане или порязване.
- △ Позволено е използването на продукта само за къпане, хигиена и цели на почистване на тялото.

УКАЗАНИЯ ЗА МОНТАЖ

- / Преди монтажа продуктът трябва да се провери за транспортни щети. След монтажа не се признават транспортни или повърхностни щети.
- / Тръбопроводите и арматурата трябва да се монтират, промият и проверят в съответствие с валидните норми.
- / Трябва да бъдат спазвани валидните в съответните страни предписания за инсталиране.

ТЕХНИЧЕСКИ ДАННИ

Арматурата е оборудвана серийно с EcoSmart® (ограничител на протичане)

Работно налягане:	макс. 1 МПа
Препоръчително работно налягане:	0,1 - 0,5 МПа
Контролно налягане:	1,6 МПа
	(1 МПа = 10 bar = 147 PSI)

Продуктът е разработен само за питейна вода!

ОПИСАНИЕ НА СИМВОЛИТЕ



Не използвайте силикон, съдържащ оцетна киселина!



РАЗМЕРИ
(вижте стр. 18)



ДИАГРАМА НА ПОТОКА
(вижте стр. 18)



СЕРВИЗНИ ЧАСТИ
(вижте стр. 21)
XXX = Цветово кодиране
000 = хром
820 = надраскан никел
930 = Polished Brass



ПОЧИСТВАНЕ
(вижте стр. 20)



ОБСЛУЖВАНЕ
(вижте стр. 19)



КОНТРОЛЕН ЗНАК
(вижте стр. 19)

МОНТАЖ (вижте стр. 17)

△ UDHËZIME SIGURIE

- △ Për të evituar lëndimet e pickimeve ose të prerjeve gjatë procesit të montimit duhet që të vishni doreza.
- △ Produkti duhet të përdoret vetëm qëllimet e banjave, të higjienës dhe të larjes së trupit.

UDHËZIME PËR MONTIMIN

- / Përpara montimit duhet që produkti të kontrollohet për dëmtime nga transporti. Pas instalimit nuk do të njihet asnjë dëmtim nga transporti ose dëmtim i sipërfaqes.
- / Tubacionet dhe rubinetet duhet që të montohen, të shpëlahen dhe të kontrollohen sipas standardeve në fuqi
- / Duhet të respektohen linjat udhëzuese të instalimit, të vlefshme për vendet respektive.

TË DHËNA TEKNIKE

Rubineti është i pajisur si standard me EcoSmart® (Kufizues qarkullimi)

Presioni gjatë punës	maks. 1 MPa
Presioni i rekomanduar:	0,1 - 0,5 MPa
Presioni për provë:	1,6 MPa
	(1 MPa = 10 bar = 147 PSI)

Produkti është projektuar ekskluzivisht për ujë të pijshëm!

PËRSHKRIMI I SIMBOLIT



Mos përdorni silikon që në përbërje ka acid acetik.



PËRMASAT
(shih faqen 18)



DIAGRAMI I QARKULLIMIT
(shih faqen 18)



PJESËT E SERVISIT
(shih faqen 21)
XXX = Kodimi me anë të ngjyrave
000 = krom
820 = nikeli i furçur
930 = Polished Brass



PASTRIMI
(shih faqen 20)



PËRDORIMI
(shih faqen 19)



SHENJA E KONTROLLIT
(shih faqen 19)

MONTIMI (shih faqen 17)

⚠ تنبيهات الأمان

⚠ يجب إرتداء قفازات لليد أثناء التركيب لتجنب حدوث أخطار الإنحشار أو الجروح.

⚠ لا يجب استخدام المنتج إلا في أغراض الاستحمام والأغراض الصحية وأغراض تنظيف الجسم.

تعليمات التركيب

/ قبل القيام بعملية التركيب، يجب فحص المنتج للتأكد من خلوه من أية تلفيات ناتجة عن النقل. بعد القيام بعملية التركيب، لن يتم الاعتراف بوجود أية تلفيات سطحية أو تلفيات ناتجة عن عملية النقل.

/ يجب تركيب وغسيل واختبار التوصيلات وخلطات المياه طبقاً للمعايير السارية.

/ يجب مراعاة القواعد الخاصة بالتركيب وأعمال السباكة وفقاً للوائح الخاصة بكل بلد.

المواصفات الفنية

يتم بشكل قياسي إنتاج الخلاط هذا مع EcoSmart® (محدد تدفق المياه)

ضغط التشغيل: الحد الأقصى 1 ميجاباسكال

ضغط التشغيل الموصى به: 0,1 - 0,5 ميجاباسكال

ضغط الاختبار: 1,6 ميجاباسكال

(1 ميجاباسكال = 10 بار = 147 PSI)

المنتج مخصص فقط لماء الشرب!

وصف الرمز

هام! لا تستخدم السليكون الذي يحتوي على أحماض! 

أبعاد 
(راجع صفحة 18)

رسم للصرف 
(راجع صفحة 18)

قطع الغيار 
(راجع صفحة 21)

XXX = الألوان

000 = كروم

820 = نيكل مُفَرَّش

930 = Polished Brass

التنظيف 
(راجع صفحة 20)

التشغيل 
(راجع صفحة 19)

شهادة اختبار 
(راجع صفحة 19)

التركيب (راجع صفحة 17) 

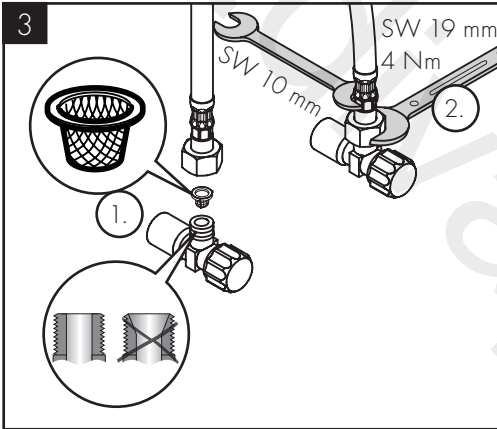
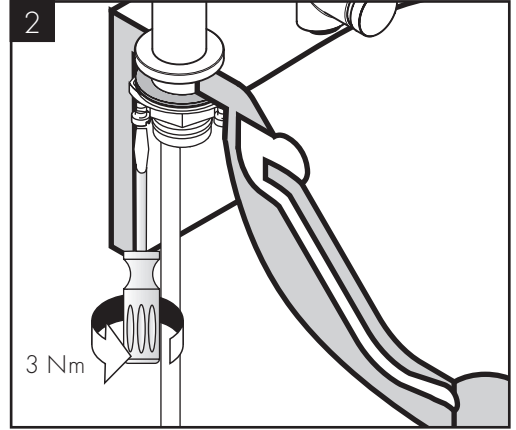
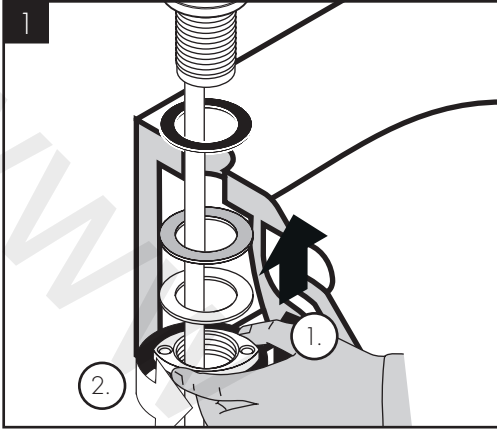

AXOR Uno
45130XXX

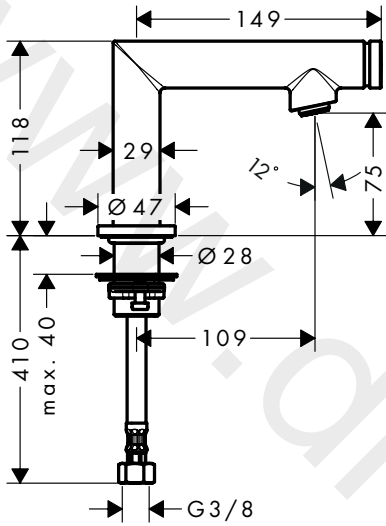

AXOR Uno
45130XXX

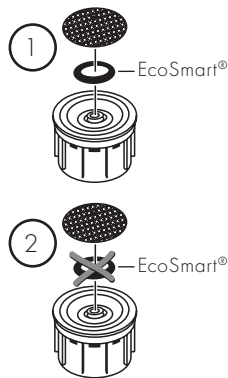
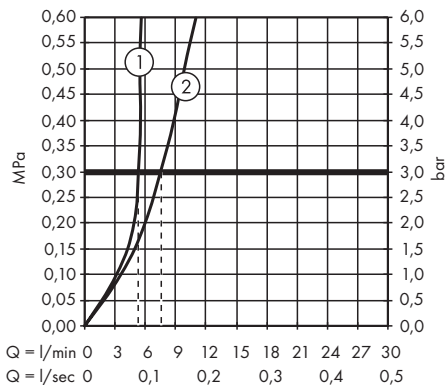

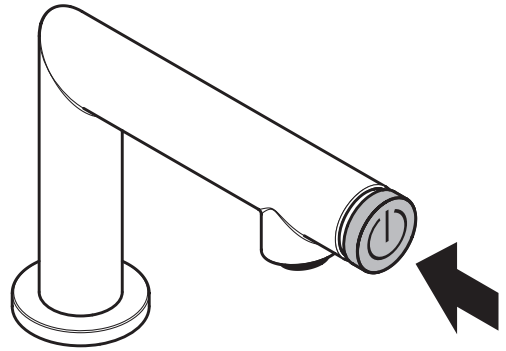
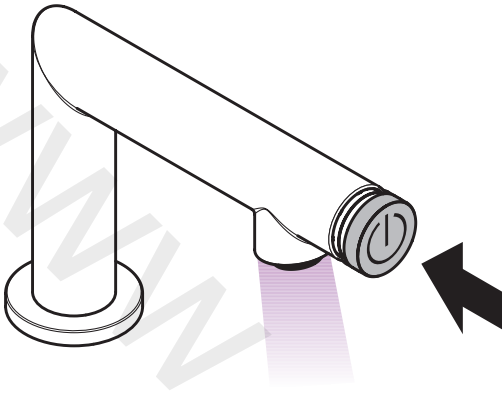

öföfnen/ouvert/open/aperto/abierto/open/äbne/abrir/
otworzyć/otevřít/otvorit/开/открыть/nyitás/avaaminen/
öppna/atidaryti/Otvoranje/açmak/deschide/ανοικτό/
odpreti/avage/atvērt/otvoriti/äpne/отваряне/hape/
فتح

schließen/fermé/close/chiudere/cerrar/sluiten/lukke/
fechar/zamknąć/zavřít/zavriť/zavrieť/关/закрыть/bezárás/
sulkeminen/siänga/uždaryti/Zatvaranje/kapatmak/
inchide/κλειστό/zapreti/sulgege/aizvērt/zatvori/lukke/
затваряне/mbylle/إغلاق



P-IX

DVGW

SVGW

ACS

WRAS

ETA



GODKENDT
TIL DRILKEVAND

45130XXX PA-IX 7309/IO

X





- DE / Reinigungsempfehlung / Garantie / Kontakt
FR / Recommandation pour le nettoyage / Garanties / Contact
EN / Cleaning recommendation / Warranty / Contact
IT / Raccomandazione di pulizia / Garanzia / Contatto
ES / Recomendaciones para la limpieza / Garantía / Contacto
NL / Aanbevelingen inzake reiniging / Garantie / Contact
DK / Rensning, anbefaling / Garanti / Kontakt
PT / Recomendações de limpeza / Garantia / Contacto
PL / Zalecenie dotyczące pielęgnacji / Gwarancja / Kontakt
CS / Doporučení k čištění / Závruka / Kontakt
SK / Odporúčania pre čistenie / Záruka / Kontakt
ZH / 清洁指南 / 担保 / 接触
RU / Рекомендации по очистке / Гарантия / Контакты
HU / Tisztítási tanácsok / Garancia / érintkezés
FI / Puhdistussuositus / Takuu / Kosketus
SV / Rengöringsrekommendationer / Garanti / Contacto
LT / Valymo rekomendacijos / Garantija / Kontaktai
HR / Preporuke za čišćenje / Garancija / Kontakt
TR / Temizleme önerisi / Garanti / Temas
RO / Recomandări pentru curățare / Garanție / Contact
EL / Σύσταση καθαρισμού / Εγγύηση / επαφή
SL / Priporočilo za čišćenje / Garancija / Kontakt
ET / Puhastussuovitused / Garantii / Kontakt
LV / Tīrīšanas ieteikumi / Garantija / Kontakti
SR / Preporuke za čišćenje / Garancija / Kontakt
NO / Anbefaling for rengjøring / Garanti / Kontakt
BG / Препоръка за почистване / Гаранция / Контакт
SQ / Këshilla rreth pastrimit / Garancia / Kontakt
KO / 세정시 권장사항 / 품질보증 / 접촉
AR / توصيات التنظيف / الضمان (الولايات المتحدة الأمريكية) / اتصال

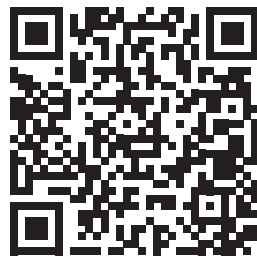

[www.axor-design.com/
cleaning-recommendation](http://www.axor-design.com/cleaning-recommendation)

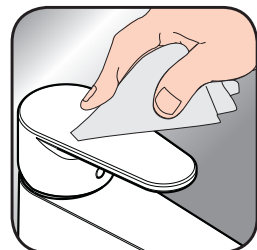

[www.axor-design.com/
cleaning-recommendation](http://www.axor-design.com/cleaning-recommendation)



[www.axor-design.com/
cleaning-recommendation](http://www.axor-design.com/cleaning-recommendation)



[www.axor-design.com/
cleaning-recommendation](http://www.axor-design.com/cleaning-recommendation)

AXOR Uno
45130XXX

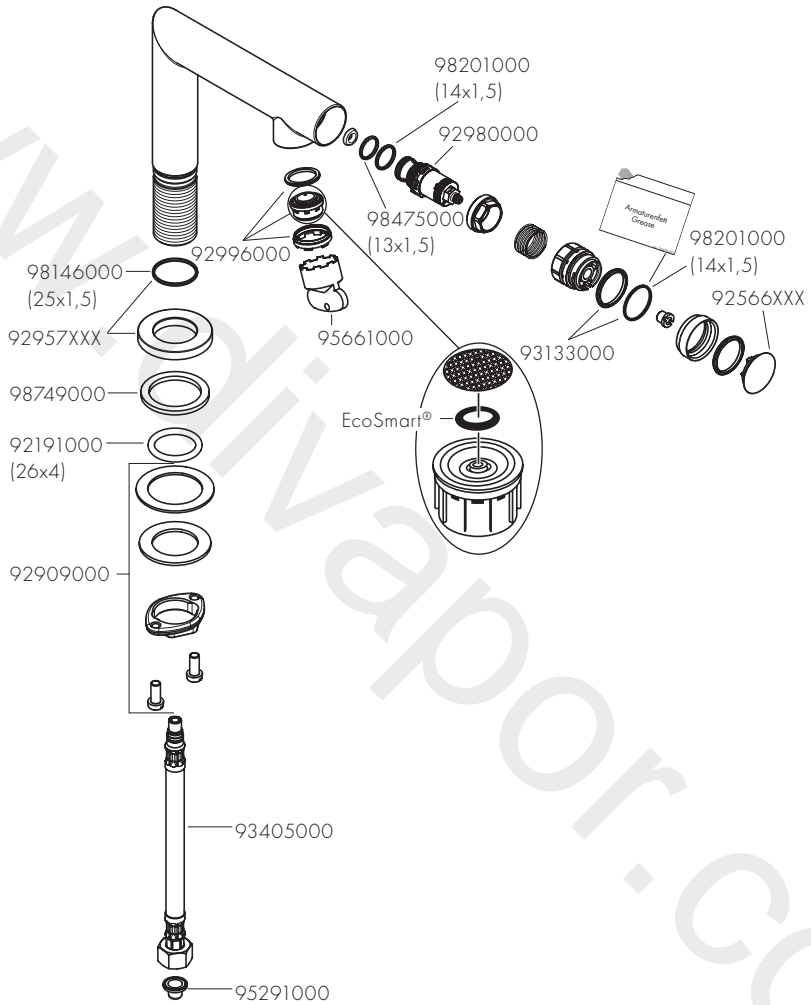

www.divapor.com

www.divapor.com

AXOR

www.divapor.com

AXOR / Hansgrohe SE
Austraße 5-9
77761 Schiltach
Deutschland

info@axor-design.com
axor-design.com

7/2018
9.06043.03