

Rebris S
Single lever basin mixer 80 with pop-up waste set
 Finish: **Chrome** Article Number: **72510000**



Description

product features

- consists of: single lever basin mixer, waste set
- ComfortZone 80
- projection: 121 mm
- spout height: 84 mm
- handle variant: lever handle
- spray type: normal spray
- maximum flow rate at 3 bar: 5 l/min
- ceramic cartridge
- temperature limitation adjustable
- suitable for continuous flow water heaters
- pop-up waste set G 1¼
- material waste set: synthetic
- connection type: G ¾ connections
- connection dimension: DN15
- EU taxonomy: max. 6 l/min - Substantial Contribution (SC) possible
- WRAS 2304315
- WRAS 2304315 - Approval letter 2304315

Article Details

Price excl. VAT 90,83 £

Technology



Design awards



Product image



Scale drawing

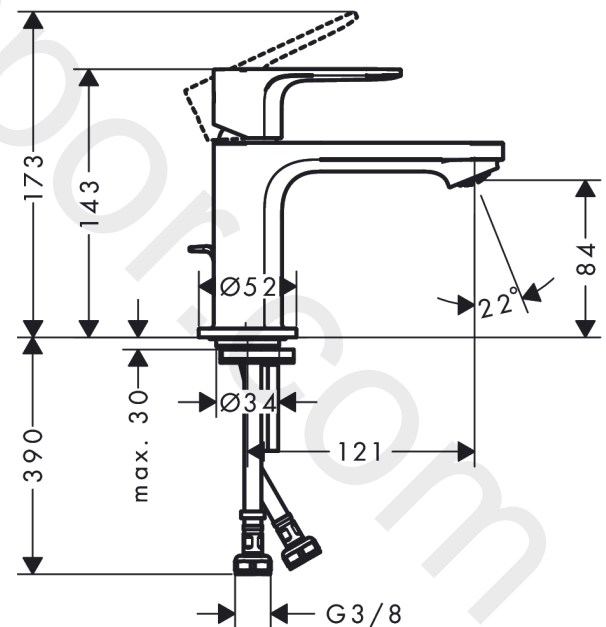

Rebris S
Single lever basin mixer 80 with pop-up waste set
 Finish: **Chrome** Article Number: **72510000**



Flowchart

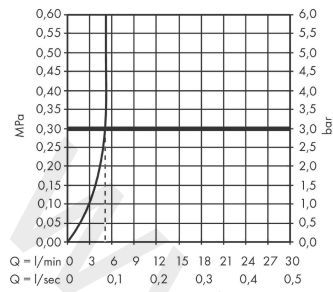

Rebris S
Single lever basin mixer 80 with pop-up waste set
 Finish: **Chrome** Article Number: **72510000**



Exploded Drawing

Year of production: >06/22

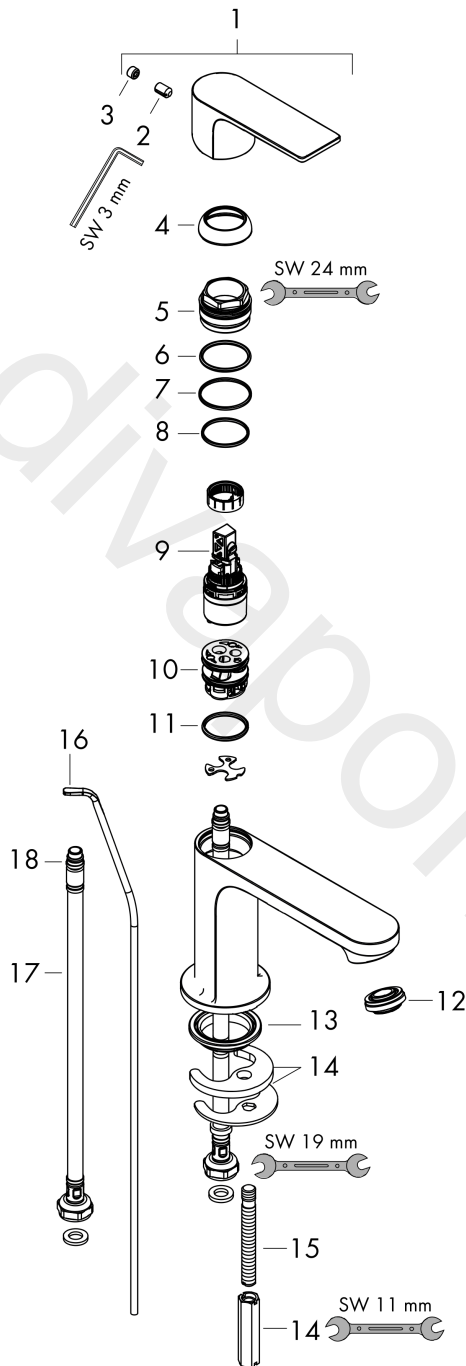

Rebris S**Single lever basin mixer 80 with pop-up waste set**Finish: **Chrome** Article Number: **72510000****Spare part list**

Year of production: >06/22

Pos.	Description	Article Number	Price	PU
1	handle	94642000	£ 51,00	1
2	hollow set screw M6x10 DIN 916	96029000	£ 3,30	1
3	screw cover	95704000	£ 3,30	1
4	flange	98863000	£ 51,00	1
5	nut	98864000	£ 43,00	1
6	O-ring 24x2	98388000	£ 3,30	1
7	O-ring 27x1,5	92527000	£ 13,30	1
8	O-ring 25x1,5	98146000	£ 3,30	1
9	cartridge, assy	95973001	£ 79,00	1
10	adapter for cartridge	98866000	£ 35,00	1
11	O-ring 23x2	98398000	£ 3,30	1
12	aerator M24x1 (5 l/min)	94364000	£ 9,00	1
13	seal Ø 42	98722000	£ 6,10	1
14	fixing set	96016000	£ 35,00	1
15	screw M8 x 68	97736000	£ 6,10	1
16	pull rod	96657000	£ 13,30	1
17	connection hose 450 mm M8x0,75 G3/8	97206000	£ 35,00	1
18	O-ring 6,6x1,6	93019000	£ 3,30	1
a	pop up waste	92168000	£ 43,00	1