

VII. Exploded Diagram

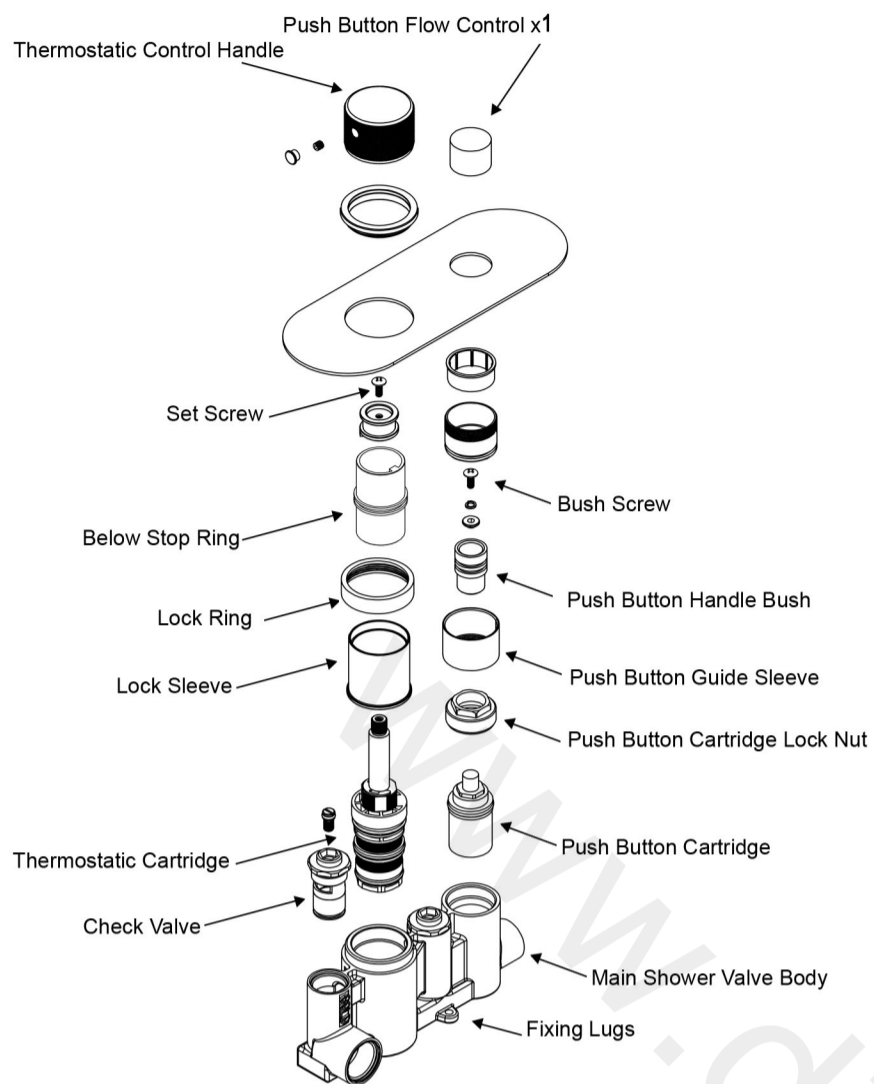

Push Button Thermostatic Shower Valve - 1 Outlet

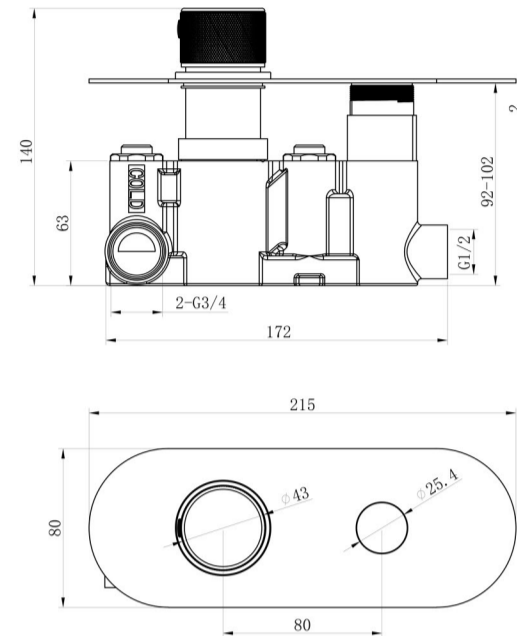

Installation & Maintenance Instructions

Please follow them carefully and leave this manual with end user

I. Operation Notice

1. The work condition for use of this product is cold water 4-29°C, hot water 55-85°C and water pressure 0.5bar - 5bar. To avoid the differential pressure between hot water and cold water, the thermostatic cartridge is preferably under the condition of water pressure 3 bar, hot water 65°C and cold water 15°C.
2. Make sure the shower valve is off when no water comes out of it (especially when nobody resides in the house or during the period of decoration or the absence of water).
3. When the room temperature drops below 0°C, take necessary measures (such measure as keeping shower valve warm and closing windows) to prevent the shower valve from being frozen or even broken (especially when windows kept open for air ventilation while nobody resides in).
4. Do not disassemble the valve unless you are an expert.

II. Installation

1. Determine the fixing position for the valve and make a recess in the wall to house the valve. The depth of the recess should be from 94mm to 101mm below the finished wall surface to fit the cover plate correctly.
2. Insert the valve into the wall recess, then mark fixing points with the mounting lugs that are cast on the valve body. Pull the valve out and drill suitable length holes at the marked positions. Use supplied plugs and screws to secure the valve.
3. Now the shower valve body is securely mounted onto the wall. Prior to installation and connecting, make sure the pipes are thoroughly flushed to remove any debris etc. Attention: Failure to do this will impair the flow of water.
4. The plumbing connections should then be made to the HOT & COLD water inlets which are clearly marked. Hot water inlet to be connected with hot supply on the left of the valve, cold water inlet to be connected with cold supply on the right of the valve. Make sure that they are correctly connected, otherwise, the thermostatic cartridge will lose its function of controlling temperature and may cause scald.
5. Make the plumbing connection to the water outlet. This will take the water to the chosen auxiliary product (shower kit) you have selected to run with this shower.
6. The plumbing connections on the inlets are 3/4" BSP female thread & on the outlets are 1/2" BSP female thread. It is recommended to apply PTFE tape to all thread connections.
7. Then turn on the water supply. Check that there is no leakage.
8. Slide the plate into position over the lock sleeves, and fit up against the finished wall surface.
9. Fit the chrome control handles. Make sure the stop lug of the below stop ring is positioning at 12 o'clock. And the red markings on the stop lug of below stop ring and the above stop ring should be in line. Remove the decorative caps/handle lever, then place the handle on the above stop ring, hold the handle firmly in position and tighten the set screw with supplied Allen key. Be careful not to turn the above stop ring. Refit the decorative caps/handle lever. The thermostatic control handle is clearly marked with H & C. For twin valves, the temperature control handle is in the bottom. For triple valves, it is in the centre.

III. Maintenance

If the water flow is less than normal and temperature control is imprecise after a period of usage. It is often due to the poor water which blocks the small filter net. The cleaning method: At first, turn off the main valve. Remove the control handles and cover plate. Then unscrew the end caps on the hot/cold water inlet sides of valve body with a coin, take out the small filter net and clear it with brush and vinegar. After completion, rinse it and reassemble all the parts back. At last, check the water flow and temperature control.

IV. Temperature Adjustment

1. The maximum temperature is factory set as 42°C. If you think it is not hot enough, you can adjust the above stop ring position to get a higher maximum temperature.
2. Remove the handle on the thermostatic control. The spline and above stop ring will be shown.
3. Remove the above stop ring by loosening the set screw. Turn the shower flow control fully on.
4. Make sure the stop lug on the below stop ring is positioning at 12 o'clock. Be careful not to turn the spline. Turn the above stop ring clockwise, place it back on to the spline. The maximum temperature will be higher. Allow water temperature to stabilise and check temperature. The maximum temperature must never exceed 46°C.
5. Achieve the temperature you want, turn the flow control off. And refit the handle.

V. Aftercare

Always clean the surface of shower valve to keep it bright. Attention: please do not use inappropriate tools such as sharp brushes, rough sponges, scouring pads or corrosive detergent to clean the shower valve. Please clean the shower valve by wet cloth and soapy water after each time of usage. Then rinse the soap out with clean water and dry with a soft cotton cloth.

VI. Faulty Diagnosis

FAULT	POSSIBLE CAUSE
Shower only runs hot or cold after installation	1. Hot and cold supplies have been plumbed the wrong way around. 2. Faulty thermostat.
Shower does not run hot enough	1. Check hot water supply temperature. 2. Maximum temperature needs adjusting, see temperature adjustment. 3. Blockage in the hot supply.
Hot water in cold supply or vice versa	1. Check and clean non-return valves
Low or no flow	1. Possible blockage in the system. 2. Operating conditions are incorrect. 3. Valve shut off as been activated due to a pressure drop in either the cold or hot supplies.
Leaking when in the off position	1. Debris in flow control cartridge. 2. Faulty flow control cartridge.
Fluctuating flow	1. Dynamic inlet pressure are not balanced. 2. Faulty thermostatic cartridge.