

GISSI®**54290**

GPF542900G001G000

data di validità/validity date
≥ 3/2018**BAGNO GESSI 316**

Parti esterne per miscelatore monocomando ad incasso con bocca, senza scarico.
External parts for built-in mixer with spout, without waste.

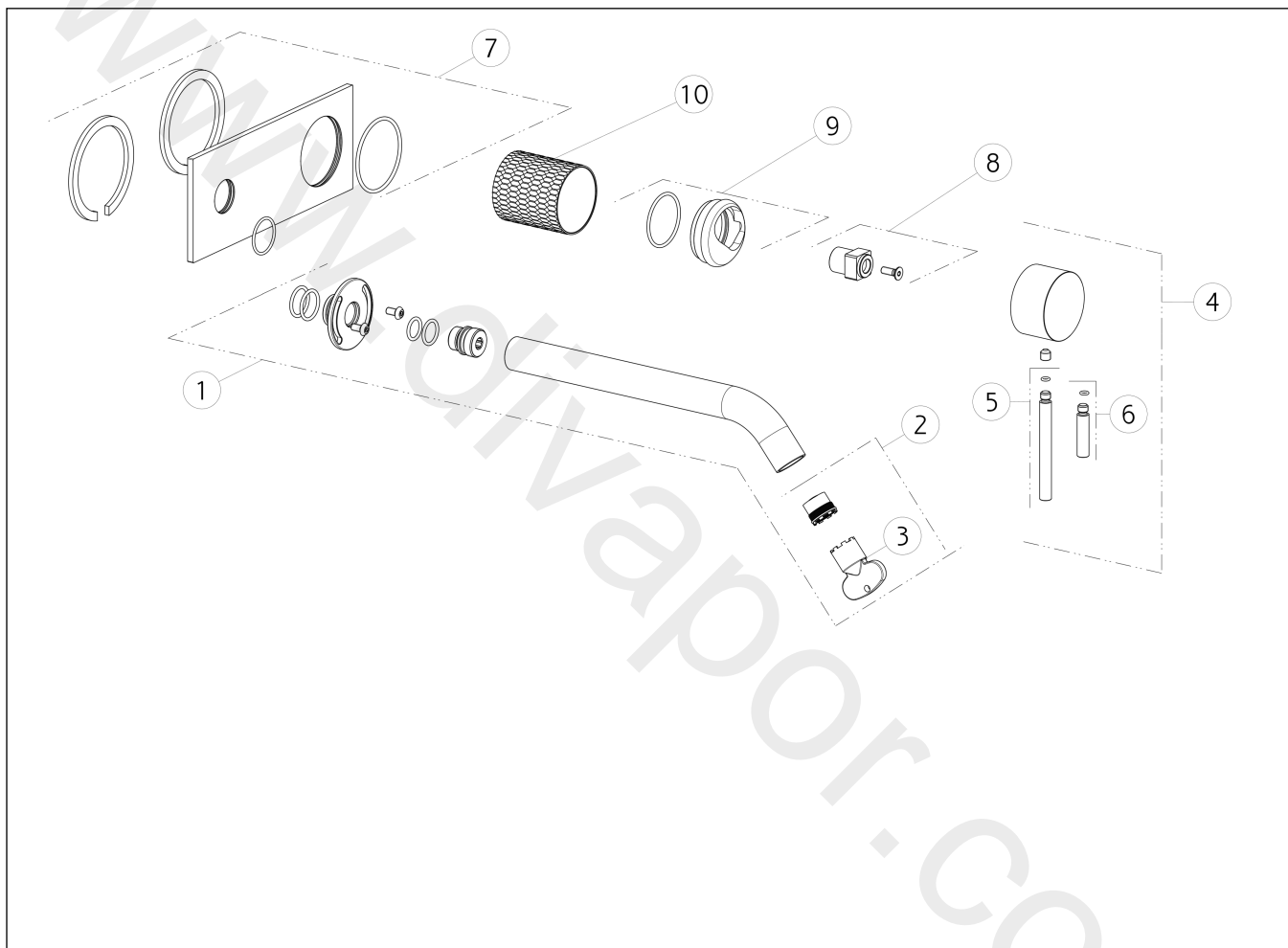

N°	Code	Descrizione	Description
1	SP01754	BOCCA COMPLETA	COMPLETE SPOUT
2	SP01608	AERATORE	AERATOR
3	SP00504	CHIAVE	SPECIAL TOOL
4	SP01746	MANIGLIA	HANDLE
5	SP01626	LEVA	LEVER
6	SP01625	LEVA	LEVER
7	SP01650	PIASTRA IN FINITURA	FINISHING PLATE
8	SP01745	DISTANZIALE	SPACER
9	SP01744	GHIERA	LOCK NUT
10	SP01755	BOCCOLA IN FINITURA	FINISHING BUSHING