

GISSI®**54392**

GPF543920G001G000

data di validità/validity date
≥ 10/2018**TRAME**

Parti esterne per gruppo lavabo tre fori ad incasso con bocca, senza scarico.
External parts for built-in three-hole basin mixer with spout, without waste.

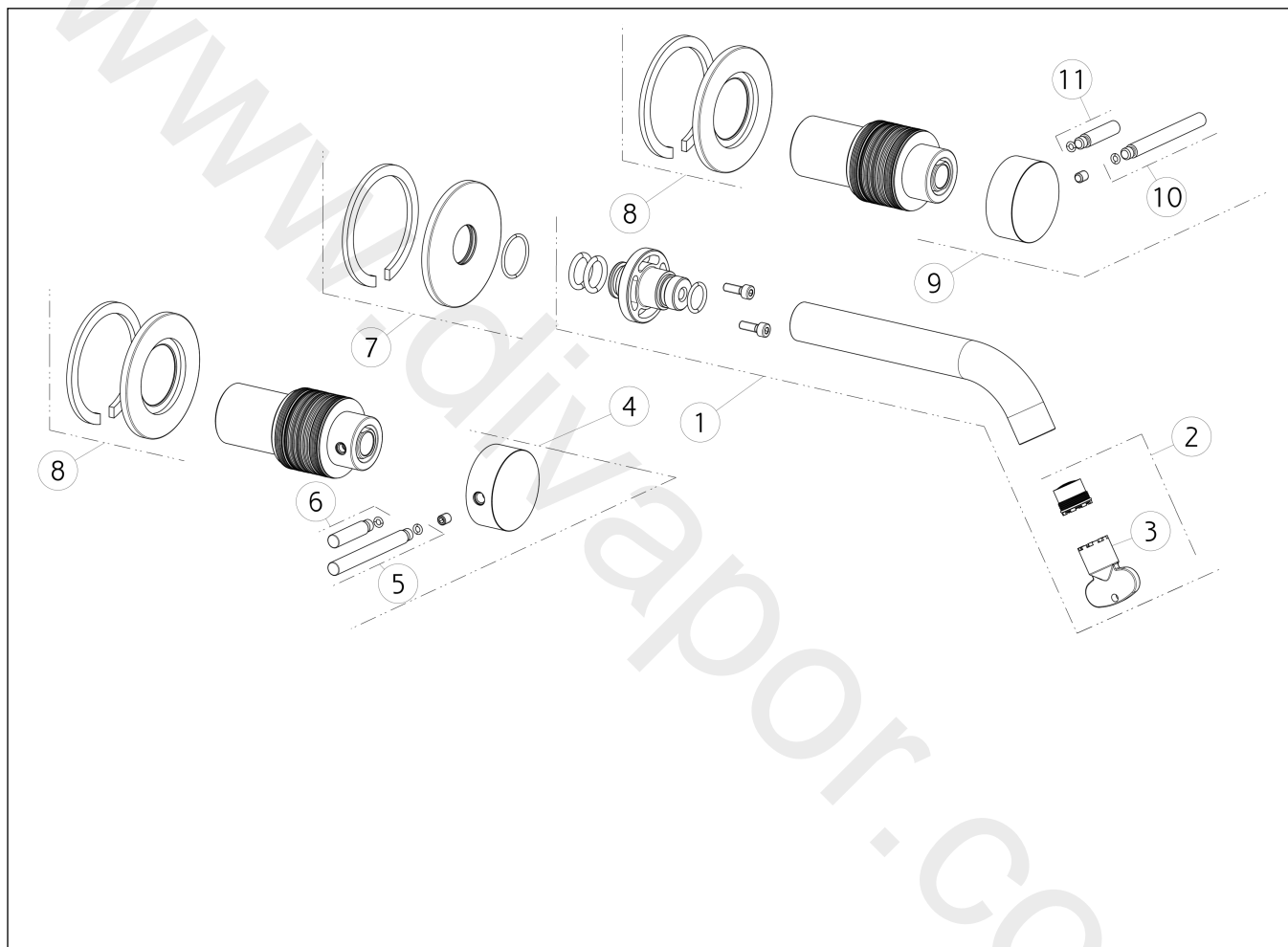

N°	Code	Descrizione	Description
1	SP02135	BOCCA	SPOUT
2	SP01608	AERATORE	AERATOR
3	SP00504	CHIAVE	SPECIAL TOOL
4	SP02180	MANIGLIA	HANDLE
5	SP01626	LEVA	LEVER
6	SP01625	LEVA	LEVER
7	SP01719	ROSONE	COVER
8	SP02178	ROSONE	COVER
9	SP02179	MANIGLIA CON LOGO	HANDLE WITH LOGO
10	SP01626	LEVA	LEVER
11	SP01625	LEVA	LEVER