

GISSI[®]**54489**

GPF544890G001G000

data di validità/validity date
≥ 7/2018**BAGNO GESSI 316**

Parti esterne per miscelatore monocomando ad incasso con bocca a lunghezza personalizzabile (min 70 max 300 mm), senza scarico.
 External parts for built-in mixer with spout, length on request (min 70 max 300 mm), without waste.

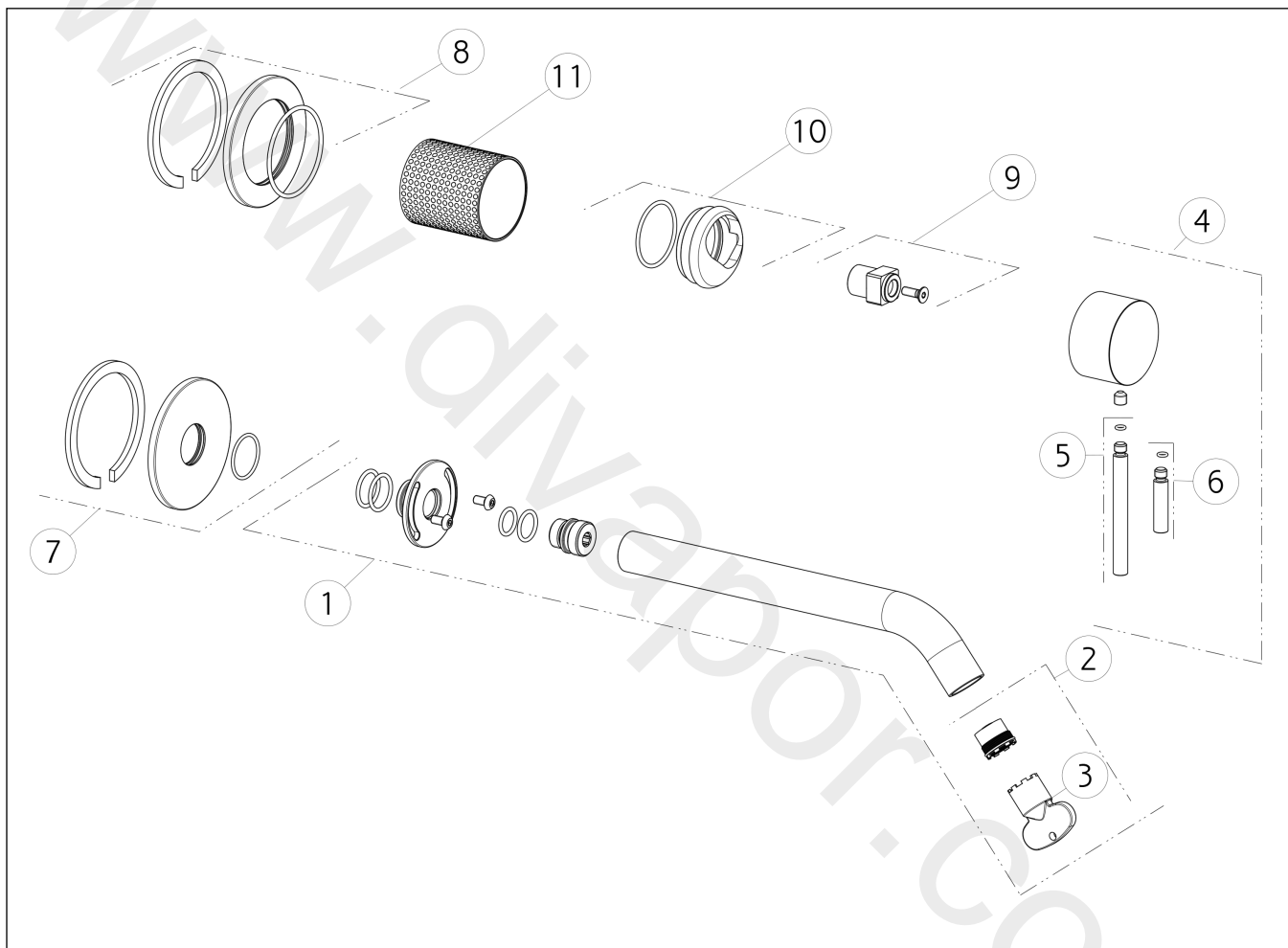

N°	Code	Descrizione	Description
1	SP01757	CANNA COMPLETA	COMPLETE SPOUT
2	SP01608	AERATORE	AERATOR
3	SP00504	CHIAVE	SPECIAL TOOL
4	SP01746	MANIGLIA	HANDLE
5	SP01626	LEVA	LEVER
6	SP01625	LEVA	LEVER
7	SP01719	ROSONE	COVER
8	SP01665	ROSONE	COVER
9	SP01745	DISTANZIALE	SPACER
10	SP01744	GHIERA	LOCK NUT
11	SP01753	BOCCOLA IN FINITURA	FINISHING BUSHING