

## Mira Vier Dual

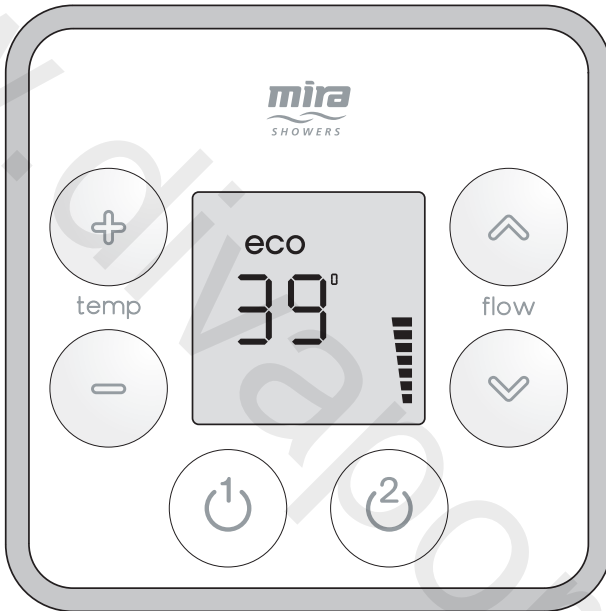

These instructions must be left with the user

User Guide

*Showering perfection*

**mira**  
SHOWERS

# CONTENTS

<b>Introduction .....</b>	<b>3</b>
General.....	3
<b>Safety Information.....</b>	<b>3</b>
<b>Control Layout.....</b>	<b>4</b>
<b>Display Symbols.....</b>	<b>5</b>
<b>Using the Shower .....</b>	<b>6</b>
Switch On/Off .....	6
Adjust Temperature .....	7
Adjust Flow.....	7
<b>Functions .....</b>	<b>8</b>
<b>Function Menu.....</b>	<b>10</b>
<b>Changing Functions/Settings .....</b>	<b>11</b>
Maximum Showering Water Temperature .....	11
Eco .....	12
Warm-Up .....	13
Clock Setting .....	14
Clock Display.....	15
Flow Range .....	16
Control Frequency.....	18
Countdown Enable.....	19
Shower Run Time.....	20
Bath Fill Mode .....	21
<b>Connecting a Second Wireless Controller.....</b>	<b>26</b>
<b>Re-Registering.....</b>	<b>27</b>
<b>Replacing the Batteries .....</b>	<b>28</b>
<b>Fault Diagnosis.....</b>	<b>29</b>
Error Codes.....	29
General Faults.....	31
<b>Cleaning .....</b>	<b>33</b>
<b>Disposal and Recycling.....</b>	<b>33</b>
<b>Notes .....</b>	<b>34</b>
<b>Customer Service.....</b>	<b>36</b>

# INTRODUCTION

## General

Thank you for purchasing a quality Mira product. To enjoy the full potential of your new product, please take the time to read this guide thoroughly and keep it handy for future reference.

The Mira Vier Dual Wireless Controller is a remote user interface and controls the following functions:

- Maximum Showering Water Temperature
- Eco Mode
- Warm-Up Mode
- Clock
- Flow Range
- Shower Run Duration
- Bath Fill Mode

This guide covers the setting and use of these functions and includes a trouble shooting guide should the appliance not function as expected. For issues relating to the installation of the appliance or other associated products, please refer to the relevant Installation Guide (s) or contact our Customer Services Team. (Details in the back of this guide.)

**NOTE! ALL FUNCTIONS ARE ONLY AVAILABLE AFTER THE CONTROLLER HAS BEEN ASSIGNED TO A MIRA VIER DUAL DIGITAL MIXER VALVE.** (See Mira Vier Dual Installation Guide.)

## SAFETY INFORMATION

1. Make sure that you fully understand how to operate this shower and make sure that it is properly maintained in accordance with the instructions given in this manual.
2. Sunburn or skin conditions can increase your sensitivity to hot water. Make sure that you set the shower to a cooler temperature.

# CONTROL LAYOUT

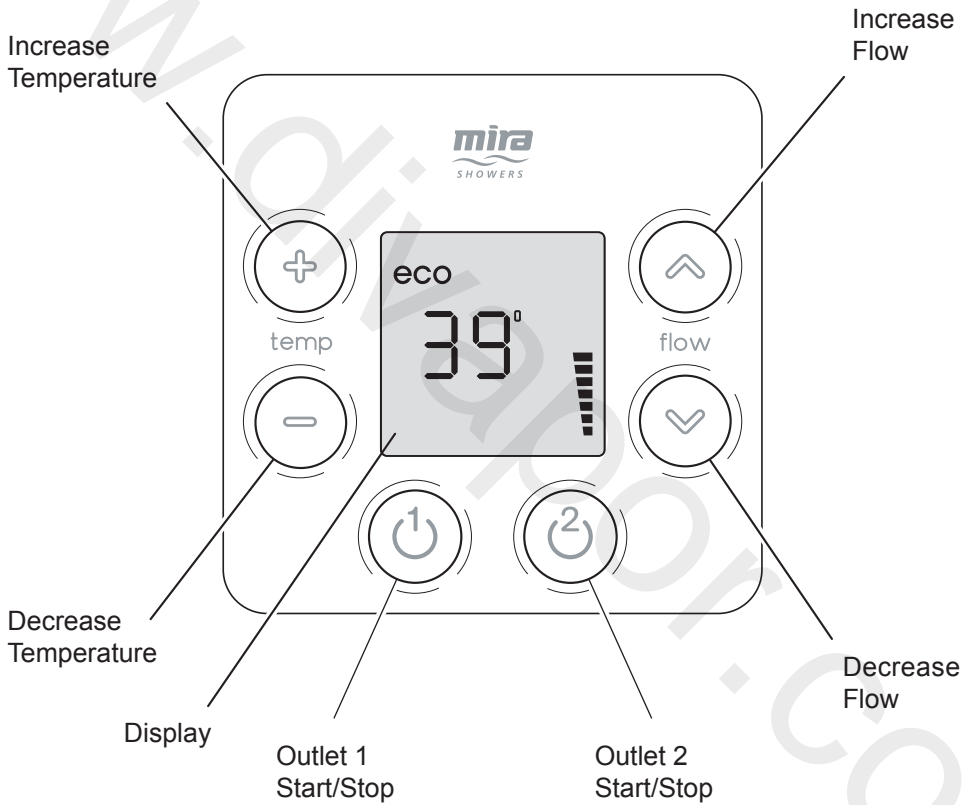



# DISPLAY SYMBOLS

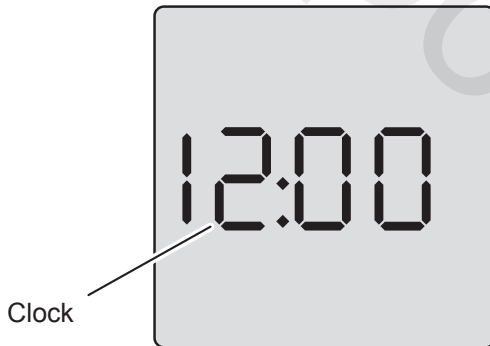
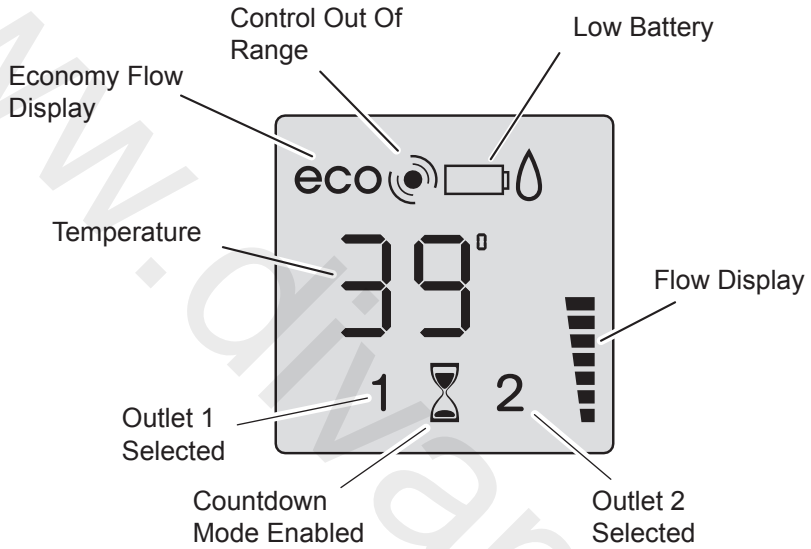

# USING THE SHOWER

## Switch On/Off

- ▶ Press “1” or “2” to start or stop each outlet.

Temperature and flow settings will be same as when last used.

After a short period, display will dim to help extend battery life.

Approximately 5 seconds after shower has stopped, display will turn off automatically.

Shower will not run continuously for more than 30 minutes before stopping automatically (5 minutes when “**ECO**” function is set to “**on**”) **Note!** The shower duration can be further defined by the user within the function menu.

When “**Warm-Up**” function is “**on**”, there will be a short delay (5 seconds) before water flows from shower.

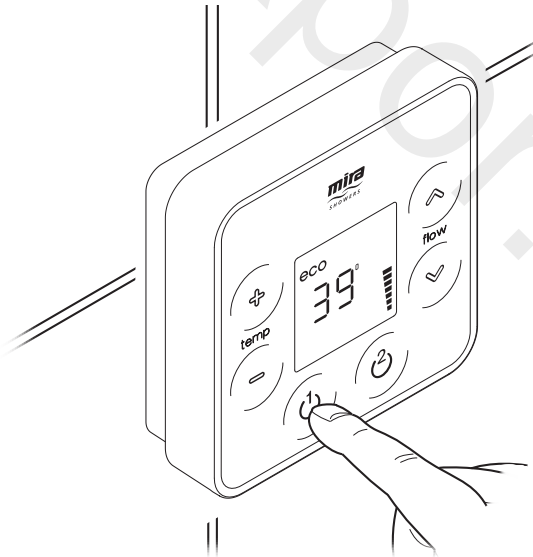

## Adjust Temperature

- ▶ While shower is running, press “+” or “-” to adjust to the desired temperature. Showering temperature appears on display in degrees Celsius ( $\pm 1^{\circ}\text{C}$ ).

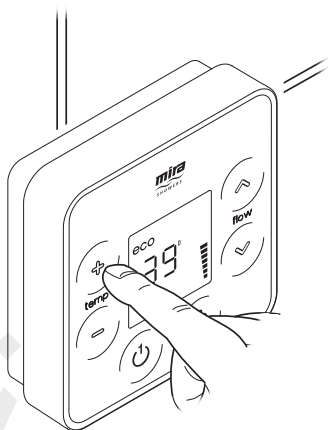

## Adjust Flow

- ▶ Press “ $\wedge$ ” or “ $\vee$ ” to adjust flow. Showering flow level appears on display in black segments.

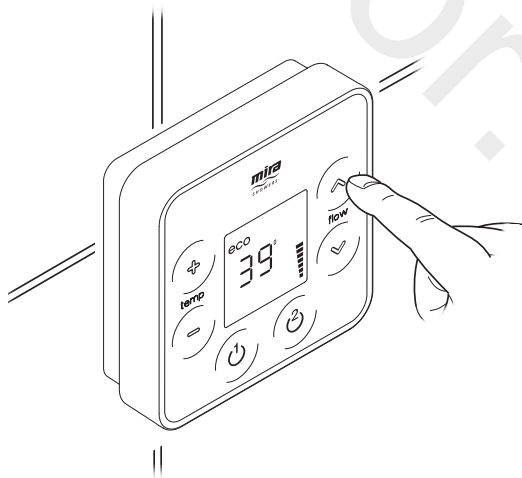

# FUNCTIONS

The following functions can be altered individually to adjust how the shower operates:

## F1 - Maximum Showering Water

**Temperature.** Adjustable per outlet, this is the temperature the shower cannot go beyond when in use.

**F2 - Eco.** The shower will stop automatically after 5 minutes. When this setting is enabled, maximum available showering flow is limited to half the flow normally produced. “ECO” symbol is displayed. When setting is “off”, maximum showering flow will be at full flow. “ECO” symbol goes out when more than half flow is selected.

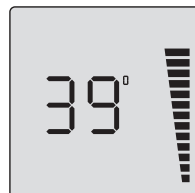
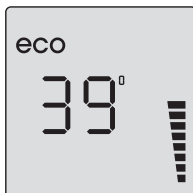

**F3 - Warm-Up.** When this setting is enabled and the shower is started, there is a short delay (5 seconds) before water flows and temperature display will flash to indicate shower is waiting for selected display temperature to be achieved. The shower stops when temperature has been reached and shower is ready for use, press “” as normal. If temperature cannot be found, shower will stop automatically after 5 minutes.

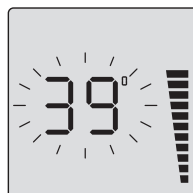

Temperature display does not flash if “Warm up” has not been enabled, shower operates as normal.

**Note!** When used with some combination boilers, the warm-up function may be impaired. This is due to the functional nature of combination boilers.

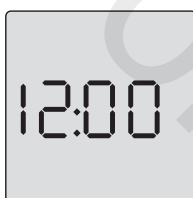

on



off

**F4 - Clock Setting.** To set the time.

**F5 - Clock Display.** When Clock Display is “on”, time is displayed when shower has stopped, or after 10 seconds of inactivity whilst the shower is running. When Clock Display is “off”, the time is replaced by the showering temperature.

**F6 - Flow Range.** For use with High Pressure/Combi Valve version only. The water flow rate (showering force) can be adjusted to within a desired range by setting a low point and a high point. During adjustment the shower will need to be started.

**F7 - Control Frequency.** An unreliable functioning of the appliance (not always able to change settings of shower) may indicate radio interference by another device transmitting locally on same channel. Changing channel may resolve this problem.

**F8 - Count Down Display Enable.** If enabled, the remaining shower time is shown instead of the clock. During the countdown the flow indicator display segments will fade but re-illuminate as each minute elapses, the Wireless User Interface will emit a single beep when 2 minutes are left on the countdown and 2 beeps as the final minute passes. For the final 10 seconds of showering the display is fully illuminated.

**F9 - Shower Run time.** If previous function (**F8 - Count Down Enable**) has been activated the operating duration of the shower can be adjusted in 1 minute increments of between 1 - 30 minutes.

**F10 - Bath Fill Mode.** Enables or disables bath fill mode, when bath fill mode is enabled the following features are available:

**Bath Fill Duration and Temperature**  
Allows the bath fill run time and temperature to be adusted.

- Bath Fill Duration - 1 - 20 minutes
- Bath Fill Temperature - 30° - 48°C

**Bath Fill Learn Mode.** Allows the Wireless User Interface to memorise both the temperature of water and the time duration required for the digital mixer valve to supply water to the bath.

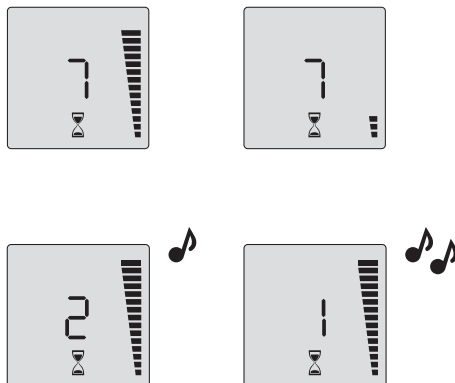

# FUNCTION MENU

## Enter the Function Menu

**Note!** If the display of the Wireless User Interface is asleep press buttons “+” and “⏻” simultaneously to ‘wake’ it before attempting to enter Function Menu.

- ▶ Press and hold “+” and “⏻” buttons simultaneously for approximately 5 - 10 seconds until “End” is displayed on the unit. The function menu can now be entered.

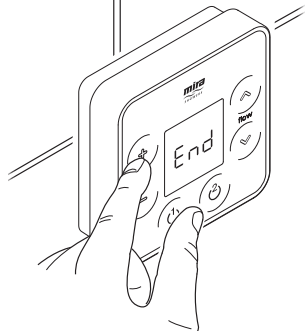

- ▶ Use “+” or “-” to cycle through functions, press “⏻” to enter a function. (See following sections in this guide for details on each function and how to alter their settings.) **Note!** If signal loss occurs during a function change, “Err” will appear on display. Press “⏻” to clear and retry function change.

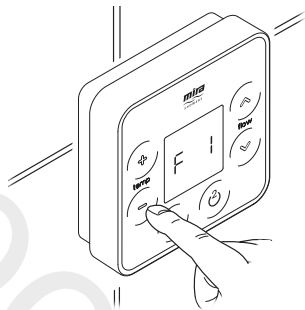

## Exit The Function Menu

- ▶ When finished, use “+” or “-” buttons to cycle back through functions until “End” appears. Press “⏻” to exit.
- ▶ Control is ready to use within 10 seconds of exiting the menu.
- ▶ If necessary, test shower to see if functions are working as expected.

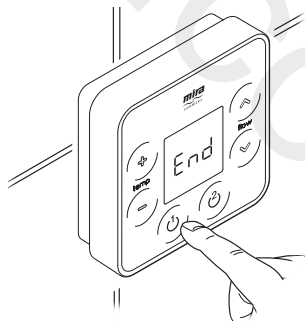

# CHANGING FUNCTIONS/SETTINGS

## Maximum Showering Water Temperature

Factory default "45°C".

- ▶ Cycle menu to "F 1" and press "⏻" to enter, then press "+" or "-" to toggle between which outlet you wish to set the maximum showering temperature to. The outlet selected will be indicated on the display.

01 = Outlet 1

02 = Outlet 2

- ▶ Press "⏻" to confirm the outlet you wish to set the maximum showering temperature to.

- ▶ Press "+" or "-" to adjust temperature.  
**Maximum = 48°C**  
**Minimum = 38°C**

- ▶ Press "⏻" to set.

- ▶ Press "⏻" to exit back to Function Menu. See section "Exit the Function Menu".

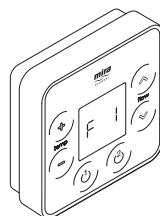
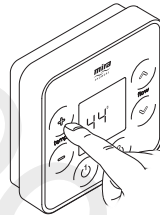
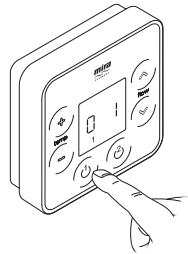
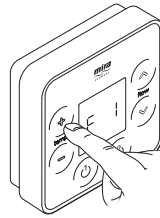

## Eco

Factory default “off”.

- ▶ Cycle menu to “F 2” and press “”.

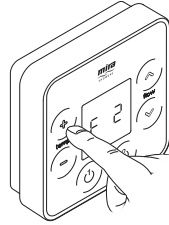

- ▶ Press “+” or “-” to change setting “on” or “off”.

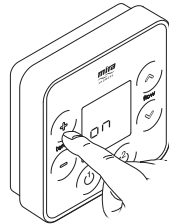

- ▶ Press “” to set.



- ▶ Press “” to exit back to Function Menu. See section “Exit the Function Menu”.

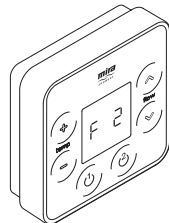



## Warm-Up

Factory default “off”.

**Note!** Function will not work with combination boilers.

- ▶ Cycle menu to “F 3” and press “1”.

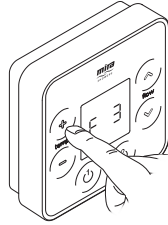

- ▶ Press “+” or “-” to change setting:  
SEL Selected outlet will warm up.

SEL

Selected outlet will warm up.

ALL

Both outlets will warm up, regardless of whether outlet “1” or “2” has been selected.

OFF

Warm up function disabled.

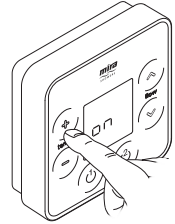

- ▶ Press “1” to set.

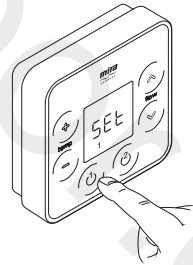

- ▶ Press “1” to exit back to Function Menu. See section “Exit the Function Menu”.

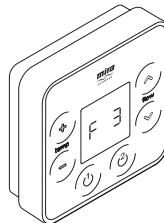

## Clock Setting

Factory default “10:00”.

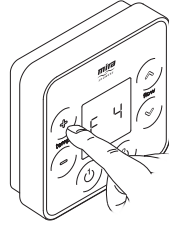

**Note!** Can also be activated by disconnecting and reconnecting battery.

- ▶ Cycle menu to “F 4” and press “”.



- ▶ Press “+” or “-” to change hour setting.

12:00

- ▶ Press “” & “” to change minute setting.

12:00

- ▶ Press “” to set time and exit back to Function Menu. See section “Exit the Function Menu”.

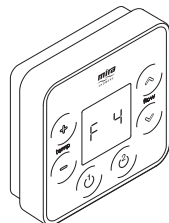

## Clock Display

Factory default “on”.

- ▶ Cycle menu to “F 5” and press “1”.

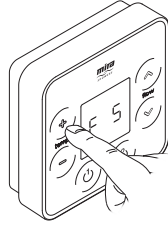

- ▶ Press “+” or “-” to change setting “on” or “off”.

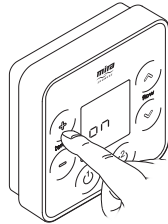

- ▶ Press “1” to set.

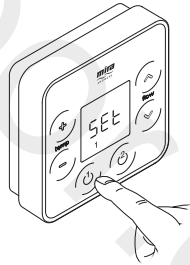

- ▶ Press “1” to exit back to Function Menu. See section “Exit the Function Menu”.

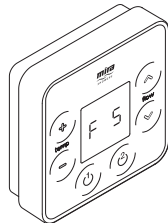

# Flow Range

For use with High Pressure / Combi Valve version only.  
Factory default "1 - 99"

- ▶ Cycle menu to "F 6" and press "⏻" to enter, then press "+" or "-" to toggle between which outlet you wish to adjust the flow range of. The outlet selected will be indicated on the display.

01 = Outlet 1

02 = Outlet 2

- ▶ Press "⏻" to confirm the outlet you wish to set the flow range to.

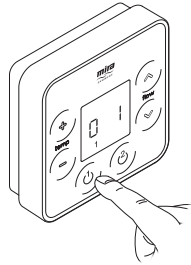
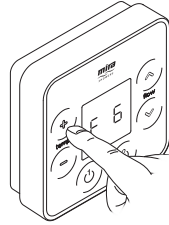

- ▶ "on" is displayed, press "⏻" to start shower.

**Note!** To exit before commencing "Flow Range" adjustment press "⏻" and "ESC" will be displayed, press "⏻" to confirm exit.

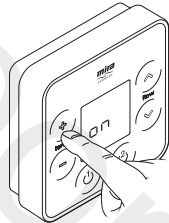

- ▶ Lower limit is displayed, e.g. "L 1". Use "⏴" & "⏵" to adjust flow to desired lower limit 1-99.

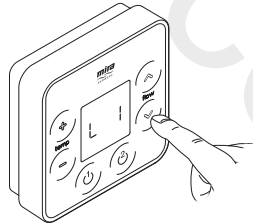

- ▶ Press “1” to set lower limit.

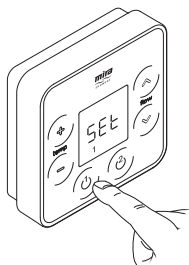

- ▶ Higher limit is displayed, e.g. “H 99”. Adjust flow to desired lower limit 1-99 using “^” & “v”.  
(Most plumbing systems may achieve maximum flow before 99.)

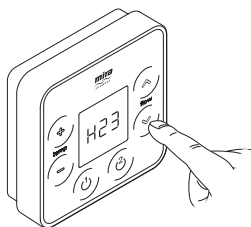

- ▶ Press “1” to set higher limit.

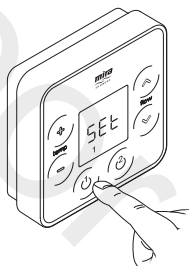

- ▶ Press “1” to exit back to Function Menu.  
See section “Exit the Function Menu”.

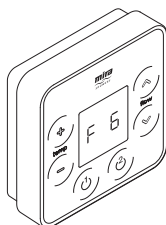

## Control Frequency

Factory default "1".

**Note!** This should only be changed if you are experiencing wireless interference.

- ▶ Cycle menu to "F 7" and press "1".

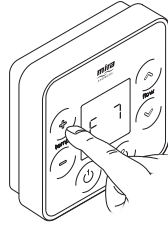

- ▶ Press "+" or "-" to change channel "1 - 3".

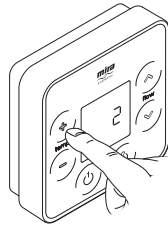

- ▶ Press "1" to set.



- ▶ Press "1" to exit back to Function Menu. See section "Exit the Function Menu".

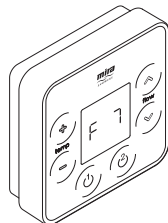

## Countdown Enable

Factory default “off”.

- ▶ Cycle menu to “F 8” and press “”.

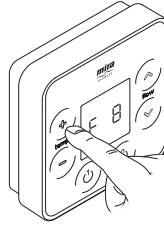

- ▶ Press “+” or “-” to change setting “on” or “off”.

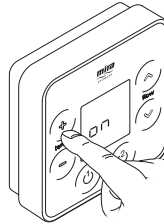

- ▶ Press “” to set.

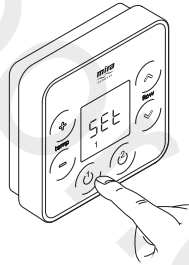

- ▶ Press “” to exit back to Function Menu. See section “Exit the Function Menu”.

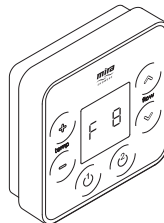

## Shower Run Time

Factory default “30 minutes”.

- ▶ Cycle menu to “F 9” and press “”.

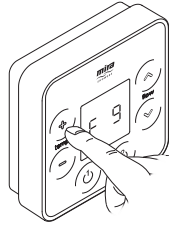

- ▶ Press “+” or “-” to change the amount of time the shower will run before switching itself off.  
Adjustable between 1 - 30 minutes.

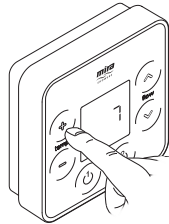

- ▶ Press “” to set.

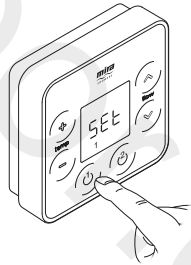

- ▶ Press “” to exit back to Function Menu. See section “Exit the Function Menu”.  
**Note!** If ‘Eco’ mode is enabled this will override any shower run time.

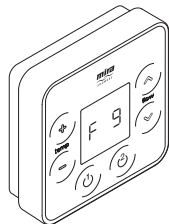



## Bath Fill Mode

Factory default “off”.

- ▶ Cycle menu to “F 10” and press “”.

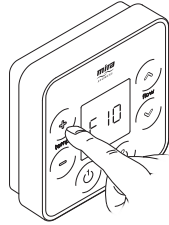

- ▶ Press “+” or “-” to toggle between options “on”, “Lrn” and “off”. **Note!** selecting either ‘on’ and ‘Lrn’ will enable further options in the function menu:

**ON** = see “Bath Fill Duration and Temperature”

**Lrn** = see “Bath Fill Learn Mode”

**OFF** = continue below

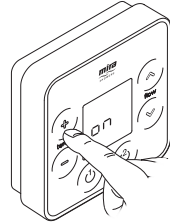

- ▶ Press “” to set.



- ▶ Press “” to exit back to Function Menu. See section “Exit the Function Menu”.

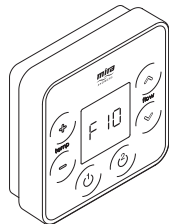

## Bath Fill Duration and Temperature - (ON)

- ▶ Cycle through menu and set **“Bath Fill Mode”** to **“on”**.

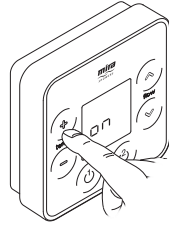

- ▶ Press **“+”** or **“-”** to toggle between which outlet you have selected to use as a bath fill. The outlet selected will be indicated on the display.

01 = Outlet 1

02 = Outlet 2

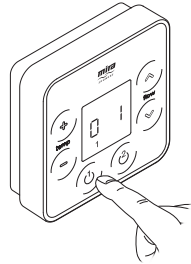

- ▶ Press **“⏻”** to select.



- ▶ Press **“+”** or **“-”** to change the amount of time the digital mixer valve will supply water to the outlet selected as a bath fill then press **“⏻”** to confirm. Adjustable between 1 - 20 minutes.

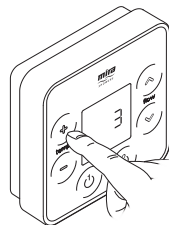

- ▶ Press “+” or “-” to adjust the temperature of the water supplied to the outlet selected as a bath fill. Adjustable between 30° - 48°C.

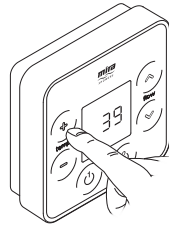

**Note!** The maximum temperature set in function F 1 will reflect the maximum selectable outlet temperature in Bath Fill Mode.

- ▶ Press “” to set.

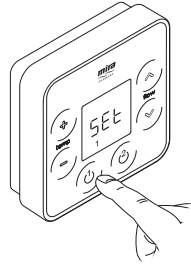

- ▶ Press “” to exit back to Function Menu. See section “**Exit the Function Menu**”.

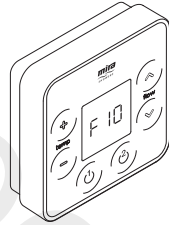

## Bath Fill Learn Mode - (Lrn)

**Note!** This function allows you to set Bath Fill parameters by actually filling the bath.

- ▶ Cycle through menu and set **“Bath Fill Mode”** to **“Lrn”**, press **“”** to select.

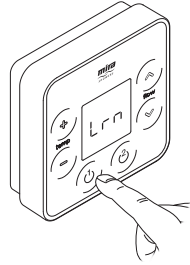

- ▶ Press **“+”** or **“-”** to toggle between which outlet has been selected as a bath fill. The outlet selected will be indicated on the display.

**01** = Outlet 1

**02** = Outlet 2

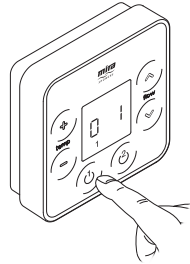

- ▶ Press **“”** to select the outlet, **“on”** is displayed.

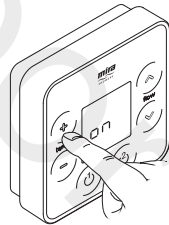

- ▶ Press **“”** and the selected digital mixer valve outlet will open and water will flow, **“Lrn”** and the outlet selected are displayed.

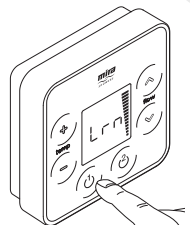

- ▶ Press “+” or “-” to adjust temperature.  
**Maximum = 48°C**  
**Minimum = 30°C**

**Note!** The maximum temperature set in function F 1 will reflect the maximum selectable outlet temperature in Bath Fill Mode.

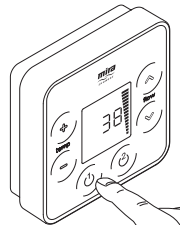

- ▶ When the water has reached the desired level and temperature press “1” to store the information.

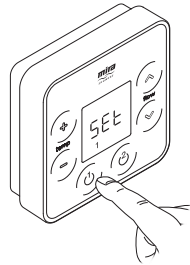

- ▶ Press “1” to exit back to Function Menu. See section “**Exit the Function Menu**”.



- ▶ **Note!** To exit at any stage of “**Bath Fill Learn Mode**” press “1” and “Esc” will be displayed, press “1” to confirm you wish to exit and the wireless controller will return to the “**F 10**” screen.

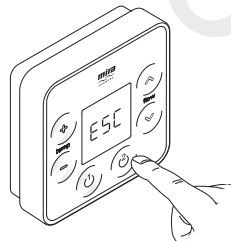

## CONNECTING A SECOND WIRELESS CONTROLLER

The following procedure details how to assign the Wireless Controller to the Digital Mixer Valve and test the remote signal strength.

**Note!** Other radio signals from sources such as mobile phones, radio controlled boiler thermostats, wireless broadband etc. can dramatically reduce the ability of the digital mixer valve to register.

It is recommended that such items are switched off during this process.

- ▶ Isolate electrical supply to the digital mixer valve.
- ▶ Bring the wireless controller to within approximately 1 m of the digital mixer valve. Fit the three AA batteries supplied into the wireless controller.

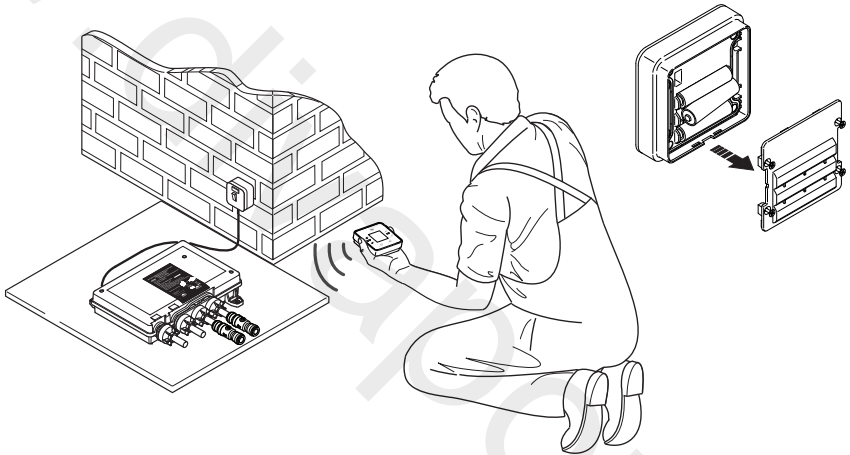

- ▶ Ensure the wireless controller LCD lights up then switch on power to the digital mixer valve.
- ▶ Depending on the type and version of your wireless controller, the software revision number (eg. r04) may be briefly displayed, the controller will then display its default time of 4:00 (unregistered).
- ▶ The digital mixer valve will now begin to make a noise as it resets itself and registers with the wireless controller.
- ▶ Droplet symbol is displayed for approximately 30 seconds. Do not remove the batteries or switch off the digital mixer valve. Droplet symbol goes out indicating the digital mixer valve and wireless controller have been assigned to each other.



Droplet  
Symbol

- ▶ Place wireless controller in approximate final position (no more than 10 m (free air) from digital mixer valve) and test wireless signal by pressing either “**U**” or “**U**”, and adjusting the temperature. If temperature display remains unchanged and “**out of range**” symbol is displayed, units are unable to communicate with each other.



Out of Range  
Symbol

- ▶ If test fails, reposition the controller closer to the digital mixer valve and repeat test until satisfied the shower will work reliably at all times.

## RE-REGISTERING

The wireless controller has previously been registered to the digital mixer valve at the factory. If communication problems are encountered, a re-registering of the wireless controller may be required.

A re-registering of the wireless controller must also be performed should the control PCB in the digital mixer valve be replaced.

To re-register the wireless controller to the digital mixer valve carry out the following sequence.

- ▶ Isolate power to the digital mixer valve.
- ▶ Press “**+**” and “**U**” buttons simultaneously until “**End**” is displayed on the screen.
- ▶ Restore power to the digital mixer valve.
- ▶ Briefly press the “**+**” and “**U**” buttons, “**SET**” will be displayed on the screen. **Note!** if display reads “**Err**” press “**U**” and repeat the process.

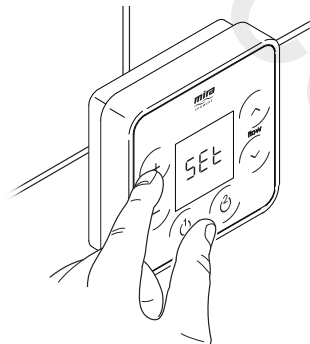
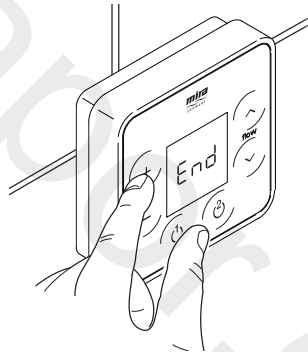

# REPLACING THE BATTERIES

Change the batteries when the low battery symbol is displayed.



To access the batteries, the controller must be removed from the wall.

▶ Press button to release and remove the controller from the wall.

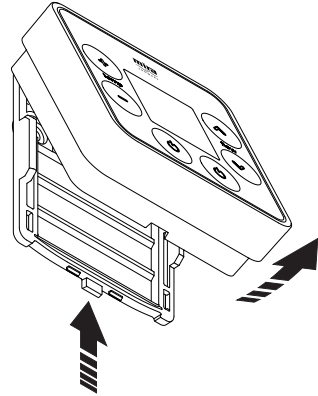

▶ Make sure the controller is dry before removing the battery cover. Turn unit over to remove the battery cover by loosening the screws with a pozi drive screwdriver.

**Note!** The screws remain attached to the battery lid.

▶ Only fit new batteries of same make and type. Do not use rechargeable batteries. Replace all three batteries at the same time.

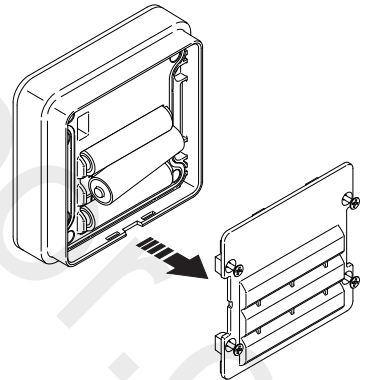

▶ When refitting the battery cover, make sure the blue seal is clean of dirt and debris. Make sure the cover is secured firmly, but do not overtighten the screws.

▶ Hook controller on top of bracket and push firmly until controller “clicks” back into place.

▶ If necessary, test shower to see if functions are working as expected.

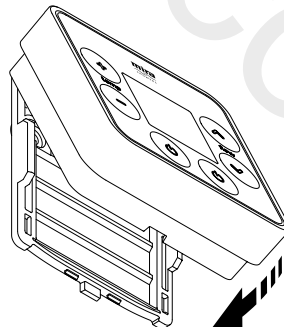



# FAULT DIAGNOSIS

## Error Codes

A specific problem relating to the electronic function of the shower will result in an error code being displayed on the control. The display will briefly flash “Err” followed by the error code number.

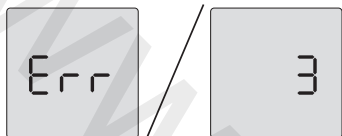

### Over Temperature at Control Sensor (E3 / E7)

1. Turn digital mixer valve off for 10 seconds. Turn back on and allow 15 seconds to reset.
2. If shower operation does not return to normal, make sure hot and cold inlets are not reversed.
3. If shower operation does not return to normal, make sure inlet filters and check valve cartridges are clean.
4. If shower operation does not return to normal, check the water supplies to the valve are within the correct temperature and pressure ranges. See “**Mira Vier Installation Guide - Specifications**”.
5. If problem still occurs, make a note of the error code and contact our Customer Services Team.

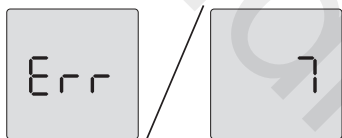

### Control Sensor (E4)

1. Turn digital mixer valve off for 15 seconds. Turn back on and allow 15 seconds to reset.
2. If shower operation does not return to normal, replace Thermistor. **(To be performed by competent tradesperson only!)**
3. If problem still occurs, make a note of the error code and contact our Customer Services Team.

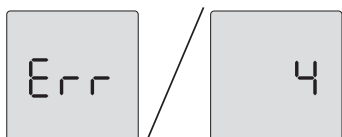

### Control Sensor or PCB Relay (E36)

1. Turn digital mixer valve off for 15 seconds. Turn back on and allow 15 seconds to reset.
2. If shower operation does not return to normal, replace Thermistor. **(To be performed by competent tradesperson only!)**
3. If shower operation does not return to normal, replace PCB. **(To be performed by competent tradesperson only!)**
4. If problem still occurs, make a note of the error code and contact our Customer Services Team.

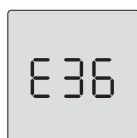



#### Digital Mixer Temperature Motor (E61)

1. Turn digital mixer valve off for 15 seconds. Turn back on and allow 15 seconds to reset.
2. If shower operation does not return to normal, check and, if necessary, replace Mixer Valve. **(To be performed by competent tradesperson only!)**
3. If problem still occurs, make a note of the error code and contact our Customer Services Team.

### Error Code Number Not Previously Described

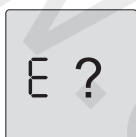

#### Digital Mixer PCB Error.

1. Turn digital mixer valve off for 15 seconds. Turn back on and allow 15 seconds to reset.
2. If problem still occurs, make a note of the error code and contact our Customer Services Team.



Replace batteries.



Control out of range.

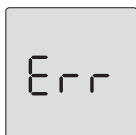

### Error During Function Change



Displayed if there is a signal loss between the wireless controller and the digital mixer valve whilst a function setting is being altered. Or, If the valve is not ready wait for 10 seconds after entering programming menu.

Press “” to clear the display and retry the function change.

## General Faults

Malfunction	Cause	Remedy
No display.	The batteries are flat or incorrectly fitted.	Check and rectify.
Shower will not operate.  +   + 	Water supply isolated. Flat batteries. Electrical supply isolated or fuse blown.  No connection to Digital Mixer Valve. Control out of range.  Digital Mixer valve malfunction.	Check water supply. Replace batteries. Check electrical supply. If fuse blown, replace Digital Mixer Valve PCB.  Reset and recommission. Refer to Installation Guide  Isolate electrical supply and reset after 30 seconds  If problem persists, contact our Customer Services Team.
No flow or low flow from Shower Fittings.	Showerhead blocked. Faulty checkvalve in showerhead. Hose blocked or twisted.  Digital Mixer Valve malfunction.  “L” and or “H” values set too low in Flow Range (F6).	Check and clean. Check and clear or replace Checkvalve. Check and clean or release twist.  Contact our Customer Services Team.  Change to higher setting.
Drip from showerhead.	A small amount of water may be retained in showerhead after showering. This may drain over a few minutes.	This is normal. Changing position of showerhead may vary draining time.
Shower not hot enough.	Maximum showering temperature set too low.  Digital Mixer Valve fitted incorrectly.	Increase maximum showering temperature (Function F1).  Make sure hot and cold water supplies are connected correctly and delivering a constant flow and temperature within the required limits. See “ <b>Specifications</b> ” in the “ <b>Mira Vier Dual Installation Guide</b> ”.  If problem persists, contact our Customer Services Team.
Incorrect or fluctuating temperature.	Controller out of range. Radio interference.  Warm up feature is being used with combi-boiler.	Refer to “ <b>Fault Diagnosis</b> ” in the “ <b>Mira Vier Dual Installation Guide</b> ”.  Disable Warm-Up feature. Refer to <b>User Guide</b> - “ <b>Warm-Up</b> ”.

Fluctuating or reduced flow.	Filters blocked. Water pressure too low. Flow rate is too low. Fluctuating water temperature.	Refer to “ <b>Fault Diagnosis</b> ” in the “ <b>Mira Vier Dual Installation Guide</b> ”.
Maximum blend temperature too hot or too cold.	Incorrect maximum temperature setting.	Refer to “ <b>Maximum Shower Water Temperature</b> ” in the “ <b>Mira Vier Dual Installation Guide</b> ”.
Continuous flow. Shower will not shut off.	Wireless Controller or Digital Mixer Valve failure.	Isolate power and water supplies. Contact our Customer Services Team.
Shower runs for a short time (30 - 60 seconds) then flow reduces, splutters or stops. Worst when other hot taps are in use. Less evident when shower is on full cold.	Air is being sucked down the vent pipe. (Pumped product / gravity fed system).  Warm up setting inadvertently selected.	The hot draw off pipe is positioned too high in relation to the lowest water level of the cold water cistern (100 mm min, refer to “ <b>Gravity Fed Showers</b> ” diagram in the “ <b>Mira Vier Dual Installation Guide</b> ”. Consider increasing size of cold feed pipe to cylinder to 28 mm diameter.  Disable Warm-Up feature. Refer to ‘ <b>Function Menu</b> ’ - “ <b>Warm-Up</b> ”.
Shower runs for a short time (3 - 5 minutes)	Cistern capacity insufficient (230 litres minimum required). Eco setting selected.  “ <b>Shower Run Time</b> ” enabled.  “ <b>Bath Fill Mode</b> ” enabled.	Increase cistern size.  Disable Eco feature. Refer to ‘ <b>Function Menu</b> ’ - “ <b>Eco</b> ”.  Increase shower run time or disable feature. Refer to ‘ <b>Function Menu</b> ’ - “ <b>Shower Run Time</b> ”.  Disable Bath Fill feature. Refer to ‘ <b>Function Menu</b> ’ - “ <b>Bath Fill Mode</b> ”.
Shower runs cool after a short time (1 - 2 minutes) then flow splutters.	Air ingress into hot pipework.	Refer to plumbing system diagrams under “ <b>Installation</b> ” in the “ <b>Mira Vier Dual Installation Guide</b> ”.for correct connection.
Shower runs cold after 5 - 10 minutes.	Insufficient storage of hot water in cylinder.	Increase storage of hot water.

## CLEANING

Many household cleaners contain abrasives and chemical substances, and should not be used for cleaning chrome plated or plastic fittings. These finishes should be cleaned with a mild washing up detergent or soap solution, and then wiped dry using a soft cloth.

## DISPOSAL AND RECYCLING

### End of Product Life

When the appliance has reached the end of its serviceable life, it should be disposed of in a safe manner and in accordance with current local authority recycling or waste disposal policy.

### Batteries

Spent batteries should not be disposed of with your normal household waste. Contact your local authority for information on waste disposal and recycling.



This symbol on the product or its packaging indicates that this product should not be disposed of with your other household waste. Instead, it is your responsibility to dispose of your waste equipment by handing it over to a designated collection point for the recycling of waste electrical and electronic equipment. The separate collection and recycling of your waste equipment at the time of disposal will help to conserve natural resources and ensure that it is recycled in a manner that protects human health and the environment. For more information about where you can drop off your waste equipment for recycling, please contact your local council office, your household waste disposal service or the shop where you purchased the product.

# NOTES

[www.divapor.com](http://www.divapor.com)

# NOTES

www.divapor.com

# CUSTOMER SERVICE

## Guarantee

Your product has the benefit of our manufacturer's guarantee which starts from date of purchase. This guarantee only applies in the United Kingdom and Republic of Ireland. To activate this guarantee, please return your completed registration card, visit our website or free phone 0800 5978551 within 30 days of purchase (UK only).

Within the guarantee period we will resolve defects in materials or workmanship, free of charge, by repairing or replacing parts or product as we may choose.

**This guarantee is in addition to your statutory rights and is subject to the following conditions :**

- The guarantee applies solely to the original installation under normal use and to the original purchaser only. The product must be installed and maintained in accordance with the instructions given in this guide.
- Servicing must only be undertaken by us or our appointed representative.  
**Note!** If a service visit is required the product must be fully installed and connected to services.
- Repair under this guarantee does not extend the original expiry date. The guarantee on any replacement parts or product ends at the original expiry date.
- For shower fittings or consumable items we reserve the right to supply replacement parts only.

**The guarantee does not cover:**

- Call out charges for non product faults (such as damage or performance issues arising from incorrect installation, improper use, inappropriate cleaning, lack of maintenance, build up of limescale, frost damage, chemical attack, corrosion, system debris or blocked filters) or where no fault has been found with the product.
- Water or electrical supply, waste and isolation issues.
- Compensation for loss of use of the product or consequential or indirect loss of any kind.
- Damage or defects caused if the product is repaired or modified by persons not authorised by us or our appointed representative.
- Routine maintenance or replacement parts to repaired or modified by persons not authorised by comply with the requirements of theTMV2 or repaired or modified by persons not authorised by TMV3 healthcare schemes
- Accidental or wilful damage.
- Products purchased ex-showroom display.

## What to do if something goes wrong

If your product does not work correctly refer to this manual for fault diagnosis and check that it is installed and commissioned in accordance with our instructions. If this does not resolve the issue, contact us for help and advice.



### Helpdesk Service

Contact our Customer Services Team for product advice, to purchase spare parts or accessories or to set up service visit. You can contact us via phone or e-mail - contact details below.

Please provide your model name, power rating (if applicable) and date of purchase.



### Mira Showers Website

([www.mirashowers.co.uk](http://www.mirashowers.co.uk))

Visit our website to register your guarantee, download user guides, diagnose faults, purchase our full range of accessories and popular spares, or request a service visit.



### Spares and Accessories

We hold the largest stocks of genuine Mira spares and accessories. Contact us for a price or visit our website to purchase items from our accessory range and popular spares. (Only available in the United Kingdom )



### Service/Repairs

No one knows our products better than our nationwide team of Service Technicians. We can carry out service or repair work to your product both during and after the guarantee period. (Only available in the United Kingdom and Republic of Ireland) Ask about our fixed price service repairs.

**To Contact Us: UK**

**0844 571 5000**



Calls cost 7p per minute plus your phone company's access charge

**Fax: 01242 282595**



Email – Visit

[www.mirashowers.co.uk/contactus](http://www.mirashowers.co.uk/contactus)



By Post: **Mira Customer Services Dept, Cromwell Road, Cheltenham, Gloucestershire GL52 5EP**



**To Contact Us: Eire Only**

**01 531 9337**



E-mail:

[CustomerServiceEire@mirashowers.com](mailto:CustomerServiceEire@mirashowers.com)



*Mira is a registered trade mark of Kohler Mira Limited.*

*The company reserves the right to alter product specifications without notice.*



**mira**  
SHOWERS