

mira

Vier

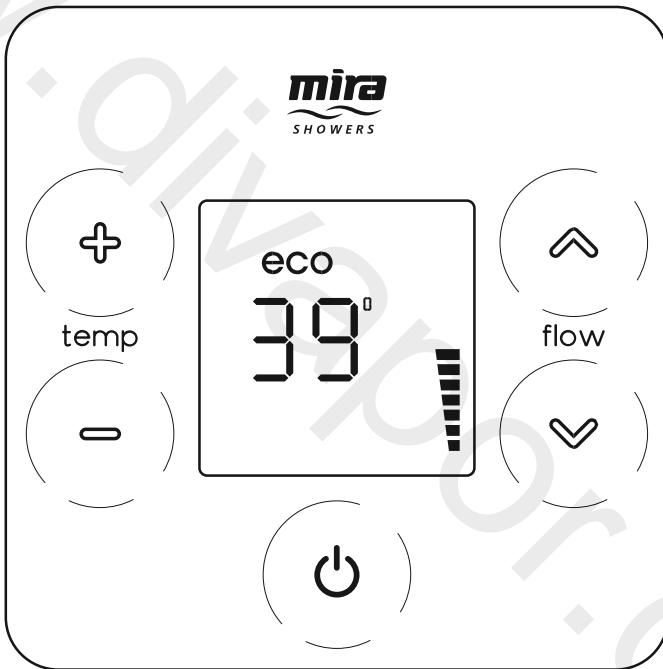

Mira Vier Wireless Controller User Guide

Customer ServicesBack Page

General

Thank you for purchasing a quality Mira product. To enjoy the full potential of your new product, please take the time to read this guide thoroughly and keep it handy for future reference.

The Mira Vier Wireless Controller is a remote user interface and controls the following functions:

- Showering Water Temperature
- Showering Water Flow
- Maximum Showering Water Temperature
- Eco Mode
- Warm-Up Mode
- Clock
- Flow Range

This guide covers the setting and use of these functions and includes a trouble shooting guide should the appliance not function as expected. For issues relating to the installation of the appliance or other associated products, please refer to the relevant Installation Guide(s) or contact our Customer Services Team. (Details in the back of this guide.)

NOTE! ALL FUNCTIONS ARE ONLY AVAILABLE AFTER THE CONTROLLER HAS BEEN ASSIGNED TO A MIRA VIER DIGITAL MIXER VALVE. (See Mira Vier Installation Guide.)

SAFETY INFORMATION

1. Make sure that you fully understand how to operate this shower and make sure that it is properly maintained in accordance with the instructions given in this manual.
2. Sunburn or skin conditions can increase your sensitivity to hot water. Make sure that you set the shower to a cooler temperature.



www.mira.com

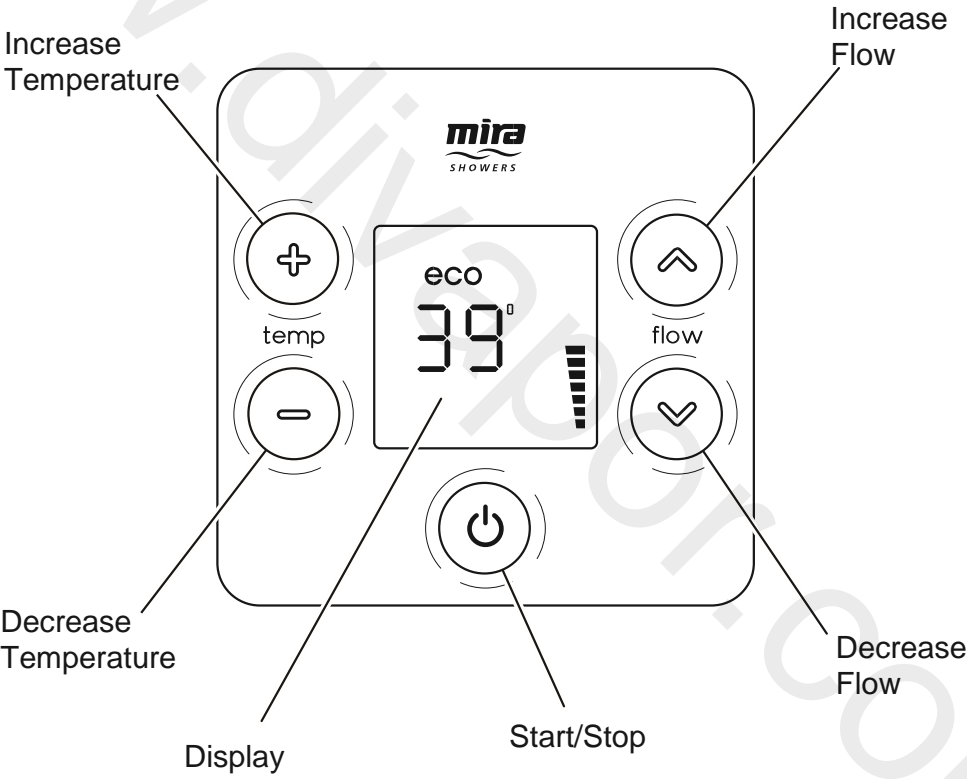

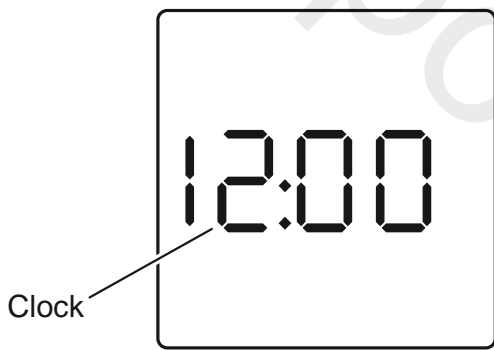
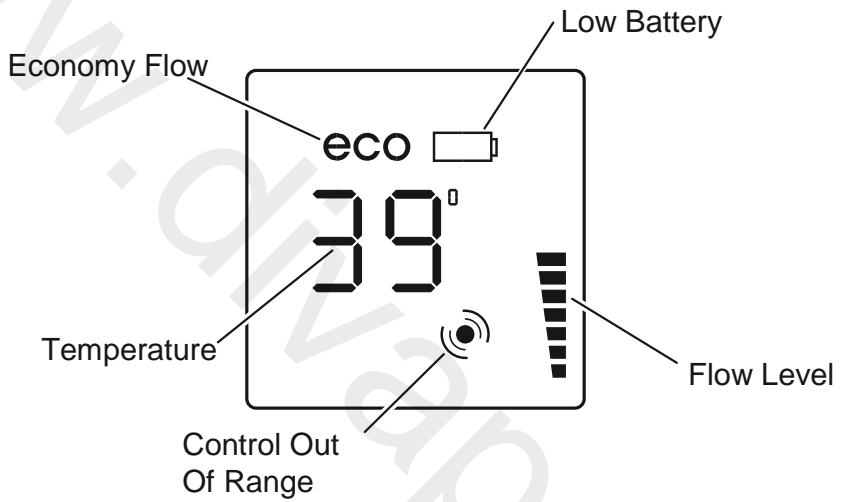

Switch on/off

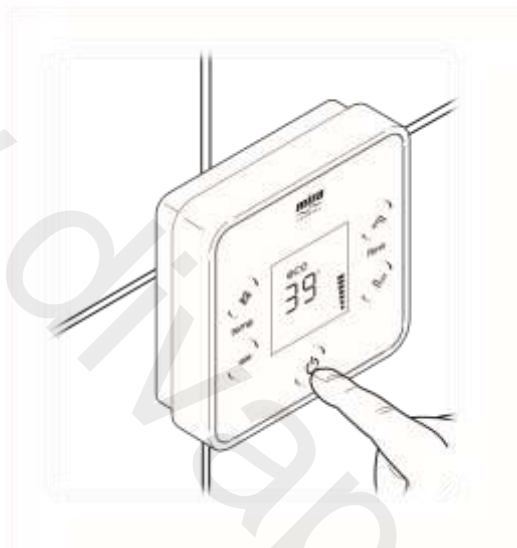

Temperature and flow settings will be same as when last used.

After a short period, display will dim to help extend battery life.

Approximately 10 seconds after shower has stopped, display will turn off automatically.

Shower will not run continuously for more than 30 minutes before stopping automatically (5 minutes when “**ECO**” function is set to “**on**”).

When “**Warm-Up**” function is “**on**”, there will be a short delay (5 seconds) before water flows from shower.

Adjust Temperature

- ▶ While shower is running, press “+” or “-” to adjust temperature. Showering temperature appears on display in degrees Celsius (°C).

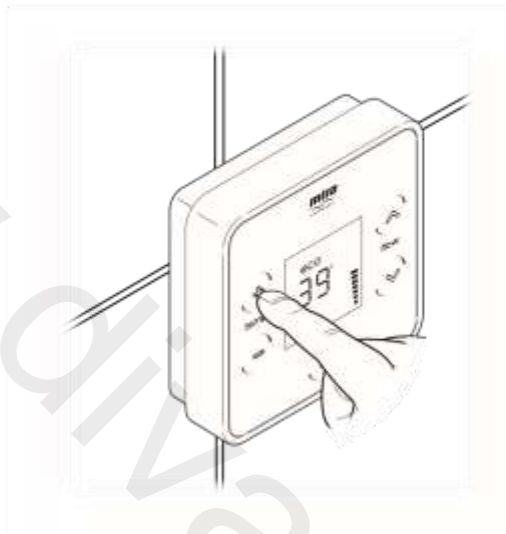

Adjust Flow

- ▶ Press “^” or “v” to adjust flow. Showering flow level appears on display in black segments.

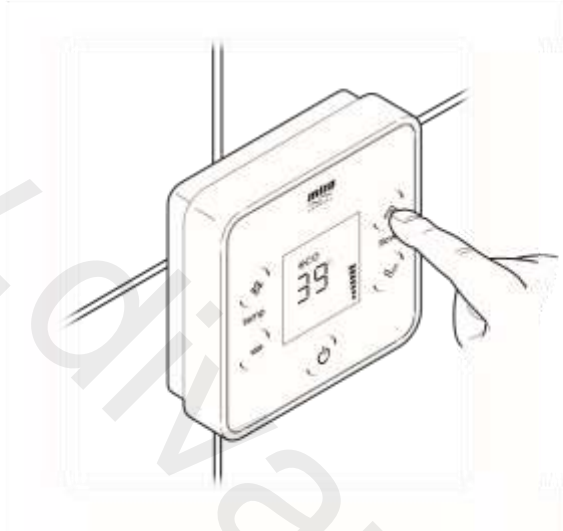

The following functions can be altered individually to adjust how the shower operates:

F1 - Maximum Showering Water Temperature. This is the temperature the shower cannot go beyond when in use.

F2 - Eco. The shower will stop automatically after 5 minutes. When this setting is “on”, maximum available showering flow is limited to half the flow normally produced. “ECO” symbol is displayed. When setting is “off”, maximum showering flow will be at full flow unless **Flow Range (F6)** is limiting the water flow. “ECO” symbol goes out when more than half flow is selected.

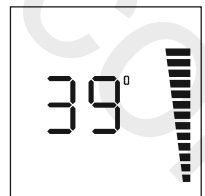
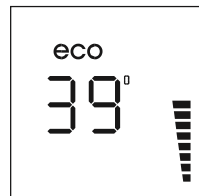

F3 - Warm-Up. When this setting is “on” and the shower is started, there is a short delay (5 seconds) before water flows and temperature display will flash to indicate shower is waiting for selected display temperature to be achieved. When shower stops, temperature has been reached and shower is ready for use, press “⏻” as normal. If temperature cannot be found, shower will stop automatically after 5 minutes.

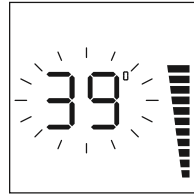

When “Warm-Up” setting is “off”, temperature display will not flash and shower operates as normal.

Note! When used with some combination boilers, the warm-up function may be impaired. This is due to the functional nature of combination boilers.

F4 - Clock Setting. To set the time.

F5 - Clock Display. When Clock Display is “on”, time is displayed when shower has stopped, or after 10 seconds of inactivity whilst the shower is running. When Clock

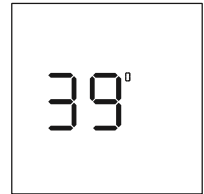

Display is “off”, the time is replaced by the **on off** showering temperature.



F6 - Flow Range. For use with High Pressure/Combi Valve version only. The water flow rate (showering force) can be adjusted to within a desired range by setting a low point and a high point. During adjustment, the shower will need to be started.

F7 - Control Frequency. An unreliable functioning of the appliance (not always able to change settings of shower) may indicate radio interference by another device transmitting locally on same channel. Changing channel may resolve this problem.

Enter The Function Menu

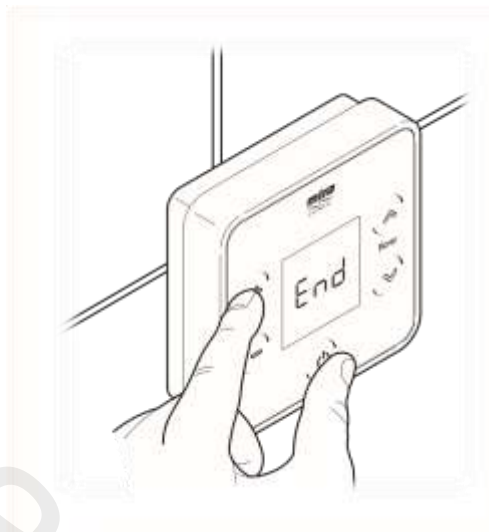
- ▶ Press “+” and “⏻” buttons simultaneously until “End” appears.



- ▶ Use “+” or “-” buttons to cycle through functions and press “” to enter setting. (See following sections in this guide for details on each function and how to alter their settings.)
Note! If signal loss occurs during a function change, “Err” will appear on display. Press “” to clear and retry function change.

Exit The Function Menu

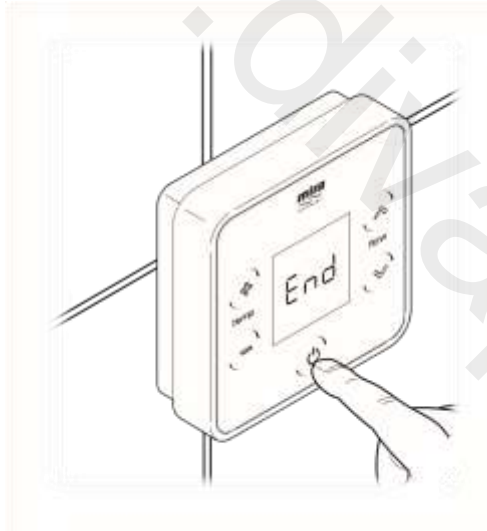
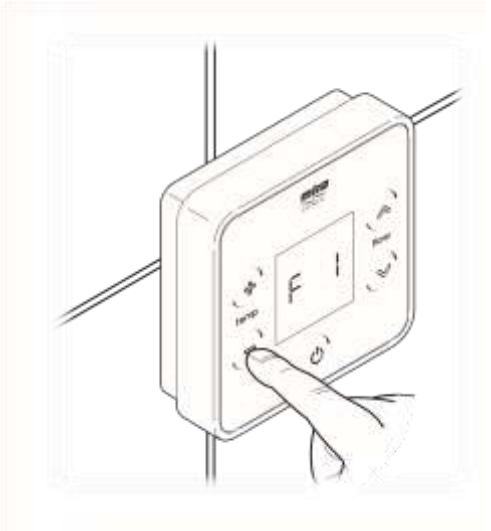

- ▶ When finished, use “+” or “-” buttons to cycle back through functions until “End” appears. Press “” to exit.

- ▶ Control is ready to use.

- ▶ If necessary, test shower to see if functions are working as expected.

Maximum Showering Water Temperature

Factory default “42°C”.

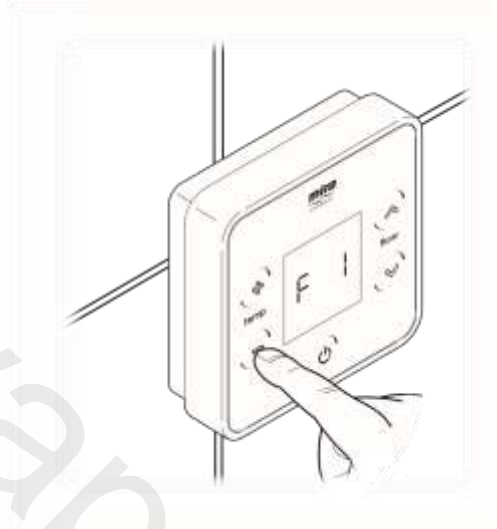



- ▶ Cycle menu to “F 1” and press “

▶ Press “+” or “-” to adjust temperature.

Maximum = 48°C

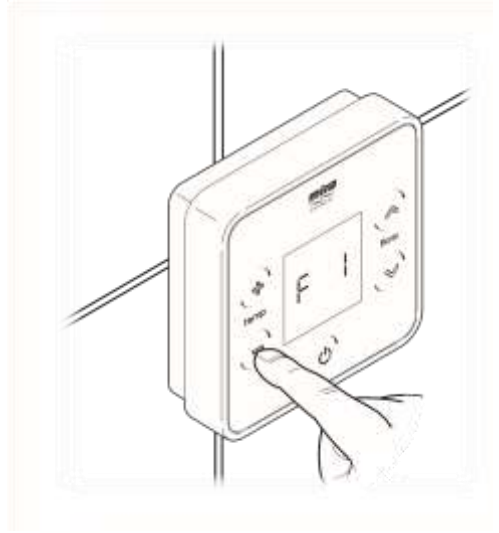
Minimum = 38°C



Press “” to

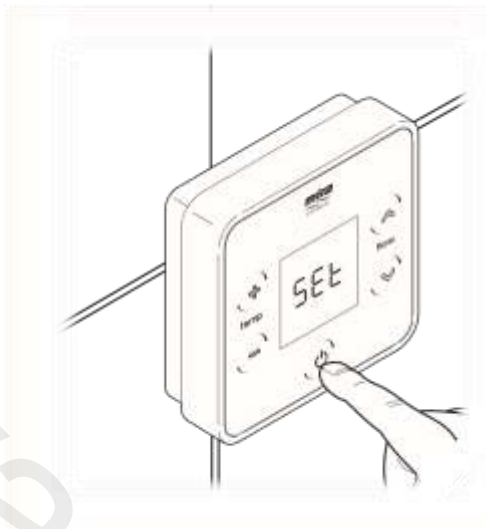

set.

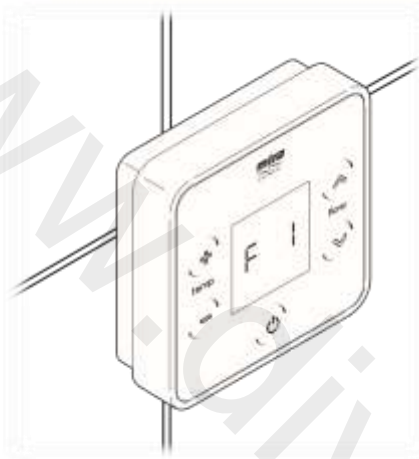

▶ Press “” to exit back to Function Menu.
See section “**Exit the Function Menu**”.

Eco

Factory default “**off**”.

www.divapor.com



Cycle menu to "F 2" and press "



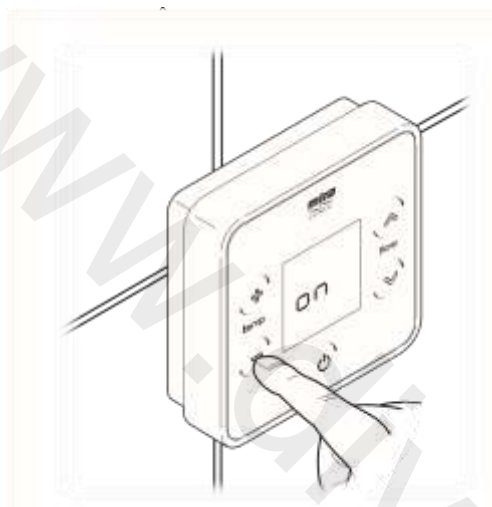

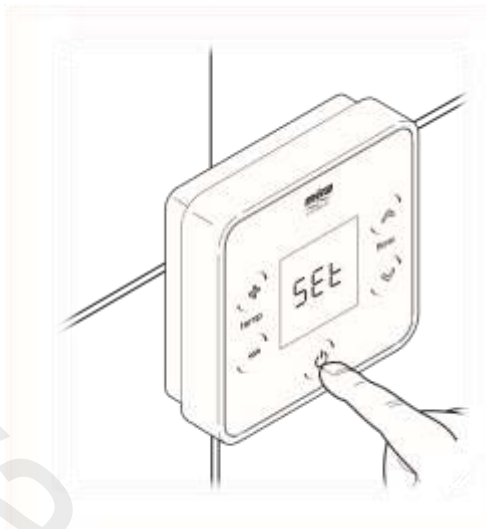

Press “ ” or “ ” to change setting to “**on**” or “**off**”.

Press “” to

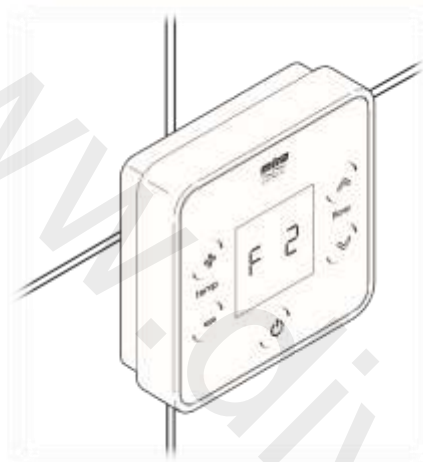

set.



▶ Press “” to exit back to Function Menu.
See section “**Exit the Function Menu**”.

Warm-Up

Factory default “off”.

Note! Function may be impaired with combination boilers.



Cycle menu to “F 3” and press “

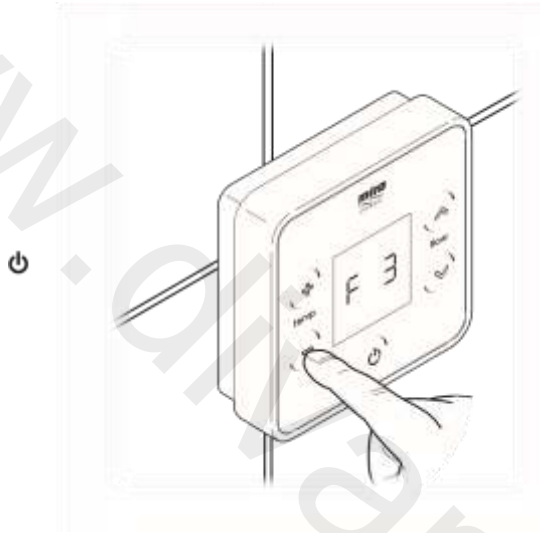

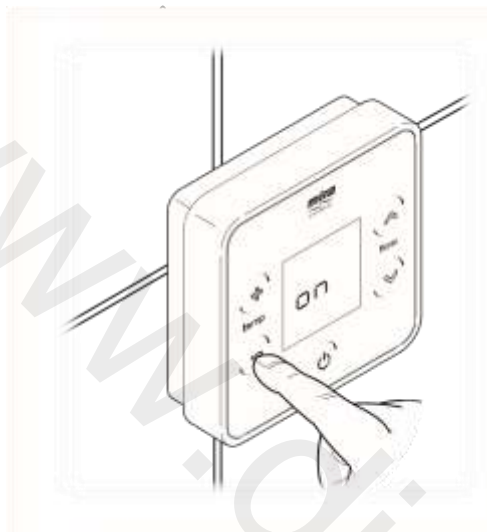

▶ Press “ ” or “ ” to

▶ change setting to “on” or “off”.

Press “ ” to set.

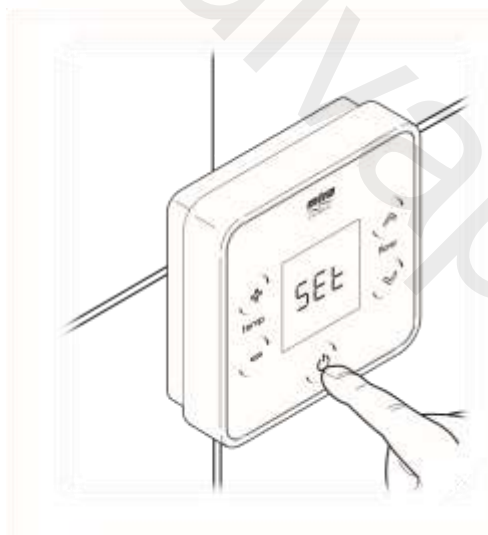

Press “⏻” to exit back to Function Menu. See section “Exit the Function Menu”.

Clock Setting

Factory default “10:43”.

Note! Can also be activated by disconnecting and reconnecting battery.

▶ Cycle menu to “F 4” and press “⏻”

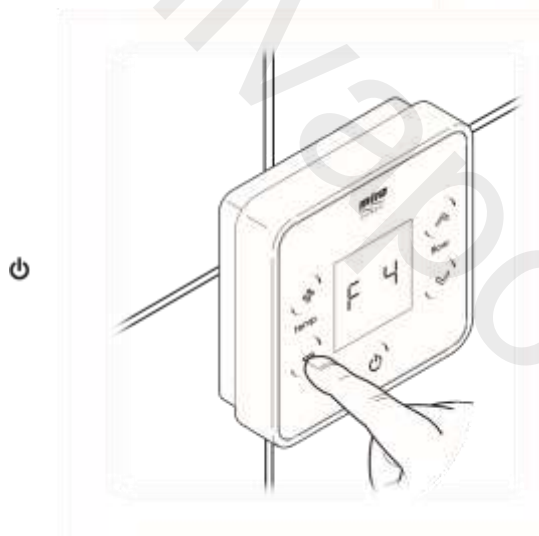
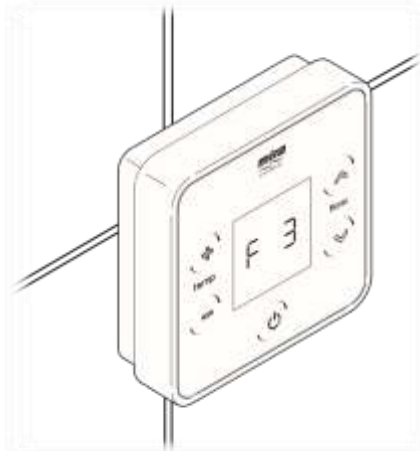



▶ Press “+” or “-” to change hour setting.

12:00

▶ Press “^” & “v” to change minute setting.

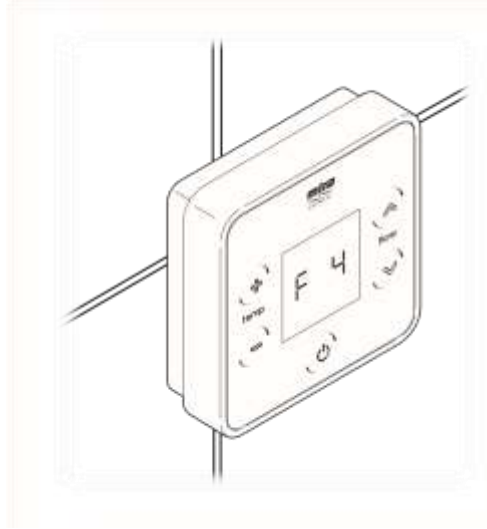
12:00



Press “” to set time and exit back to Function Menu. See section “**Exit the Function Menu**”.

Clock Display

Factory default “on”.

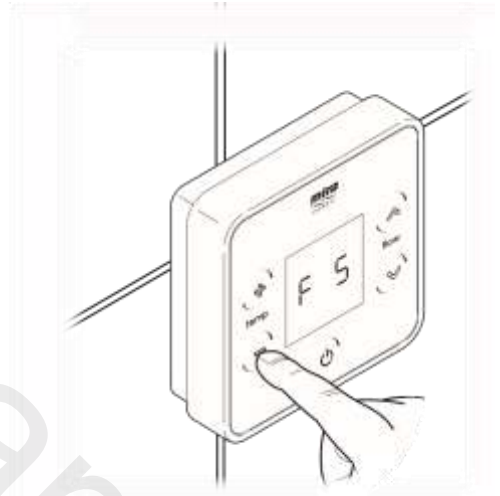

Cycle menu to “F 5” and press “

”.



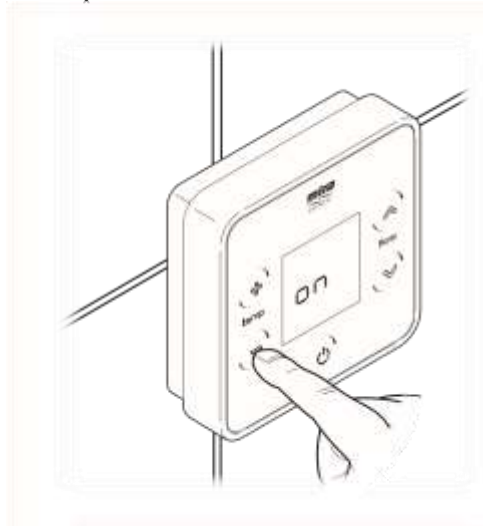

Press “ ” or “ ” to change setting to “on” or “off”.



Press “ ” to set.

▶ Press “⏻” to exit back to Function Menu. See section “Exit the Function Menu”.

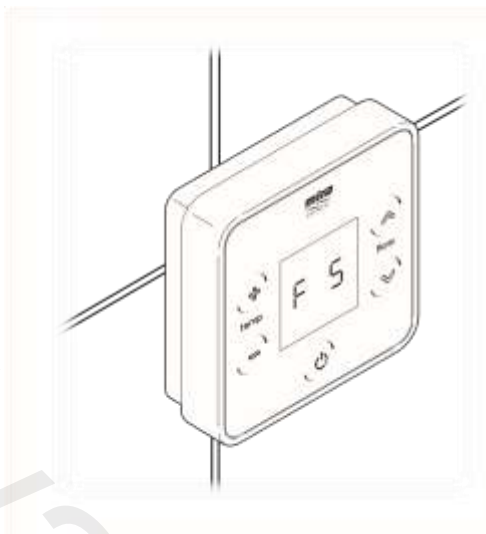

Flow Range

For use with High Pressure/Combi version only.
Factory default "1 - 99".



Cycle menu to "F 6" and press "

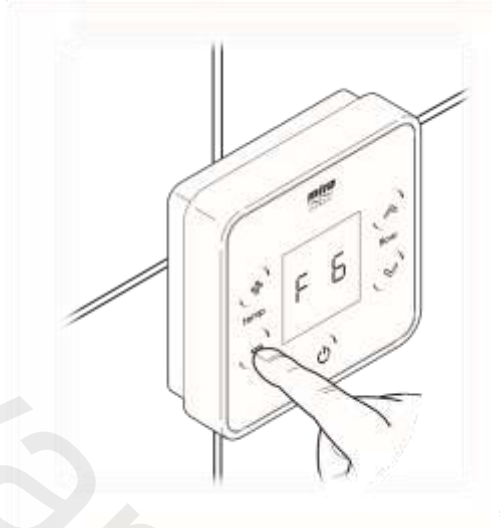

Press
"⏻"

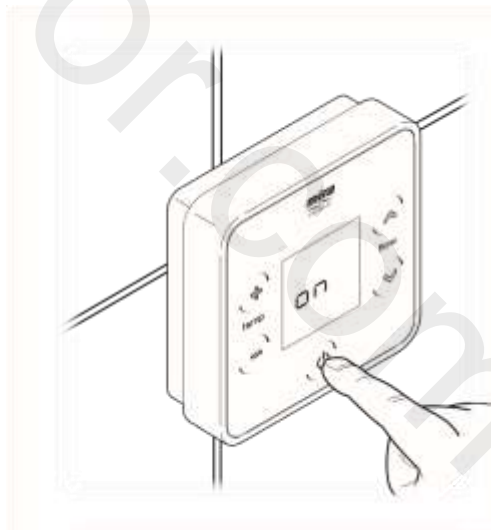

again to access the flow range limits.

▶ Water begins to flow and the lower limit is displayed, e.g. "L 1". Adjust flow to desired lower limit 1-99 using " " & " ".

Note! If hot water is supplied from a combination boiler, make sure the lower limit is sufficient to activate the boiler.

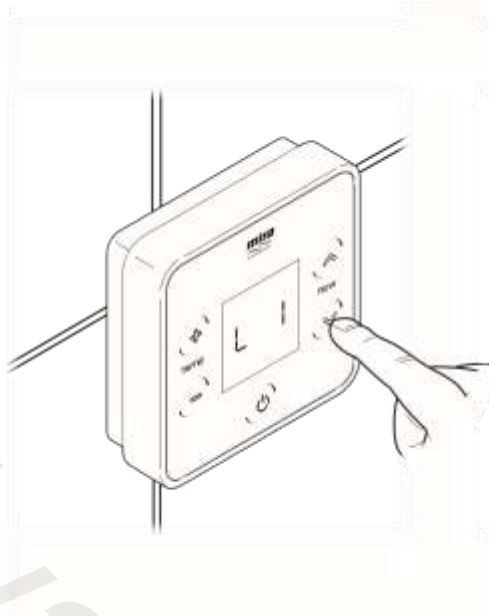

▶ 

Press "" to set lower limit.

▶

▶ 

Water

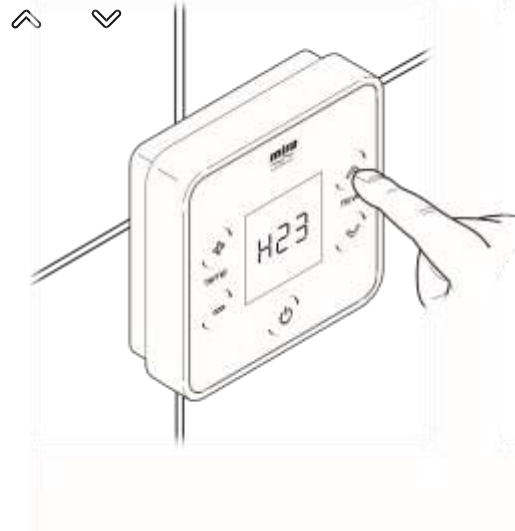

continues to flow and the higher limit is displayed, e.g. "H23". Adjust flow to desired higher limit 1-99 using " " & " ".

Press " " to set higher limit. Water flow stops.

▶ Press “” to set and exit back to Function Menu. See section “**Exit the Function Menu**”.

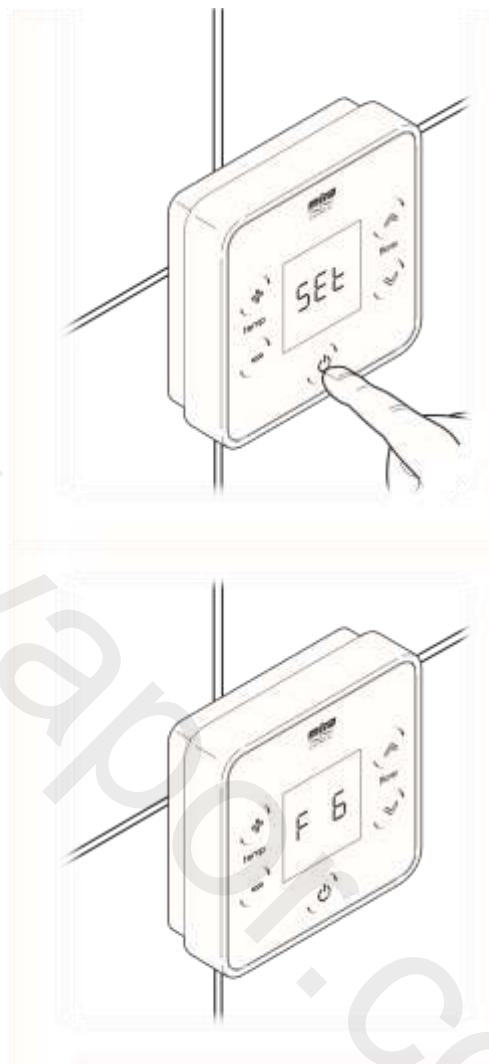

Control Frequency

Factory default "1".



Cycle menu to "F 7" and press "

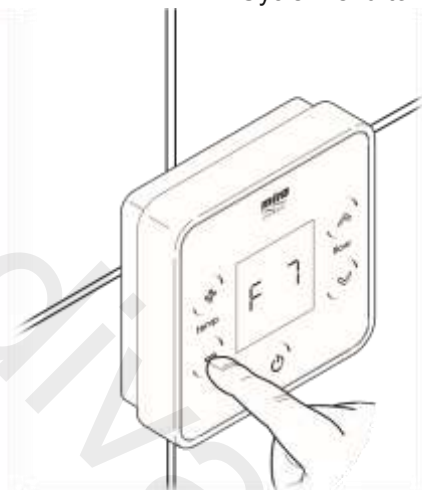

."



Press "+" or "-" to change channel "1-7".

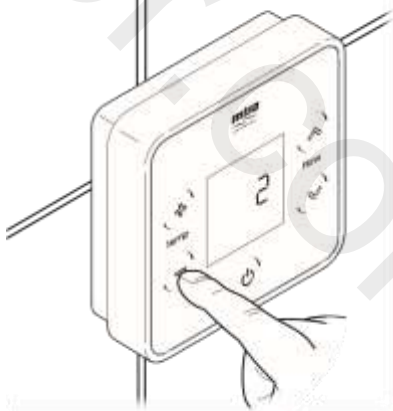

Press “” to set.

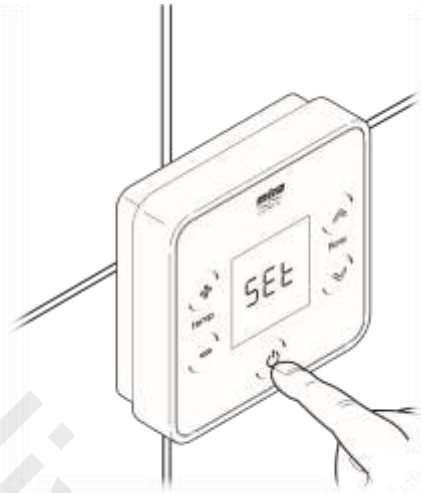

- ▶  Press “” to exit back to Function Menu. See section “Exit the Function Menu”.

REPLACING THE BATTERIES

Change the batteries when the low battery symbol is displayed.

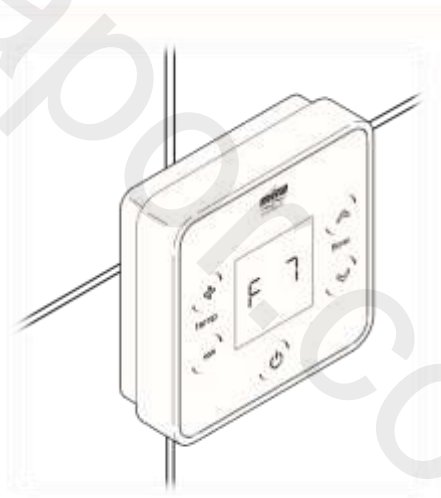

 To access the batteries, the controller must be removed from the wall.

- ▶ Press button to release and remove the controller from the wall.

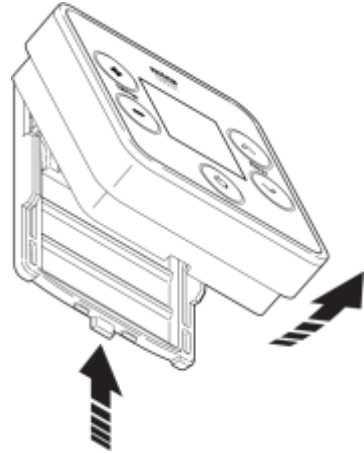

- ▶ Make sure the controller is dry before removing the battery cover. Turn unit over to remove the battery cover by loosening the 4 screws with a pozi-drive screwdriver. **Note!** The screws remain attached to the battery lid.

- ▶ Remove and replace all batteries. Only use batteries of same make and type. Do not use rechargeable batteries. **Note!** When batteries are replaced, controller activates “Clock Setting” mode automatically. Reset the time and press “⏻”.

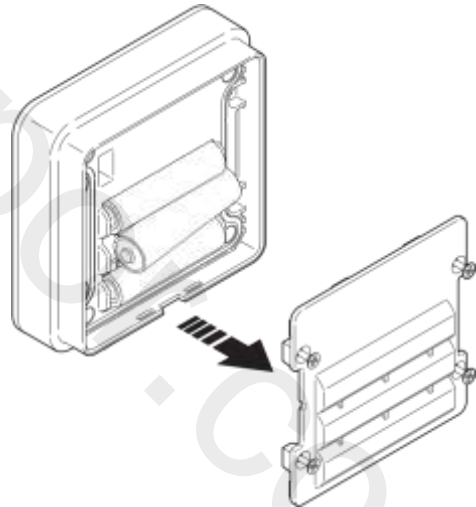

- ▶ When refitting the battery cover, make sure the blue seal is clean of dirt and debris. Make sure the cover is secured firmly, but do not overtighten the screws.

- ▶ Hook controller on top of bracket and push firmly until controller “clicks” back into place.

If necessary, test shower to see if functions are working as expected.

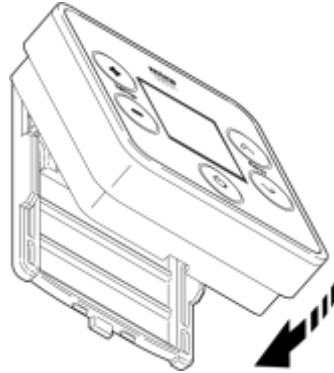

FAULT DIAGNOSIS

Error Codes

A specific problem relating to the electronic function of the shower will result in an error code being displayed on the control.

Over Temperature at Control Sensor

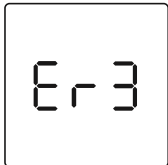

1. Turn Digital Mixer off for 10 seconds. Turn back on and allow 15 seconds to reset.
2. If shower operation does not return to normal, make sure hot and cold inlets are not reversed.
3. If shower operation does not return to normal, make sure inlet filters and check valve cartridges are clean.

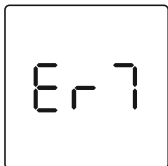

4. If shower operation does not return to normal, check the water supplies to the valve are within the correct temperature and pressure ranges. See “**Mira Vier Installation Guide - Specifications**”.

5. If problem still occurs, make a note of the error code and contact our Customer Services Team.

Control Sensor



1. Turn Digital Mixer off for 15 seconds. Turn back on and allow 15 seconds to reset.
2. If shower operation does not return to normal, replace Thermistor. **(To be performed by competent tradesperson only!)**
3. If problem still occurs, make a note of the error code and contact our Customer Services Team.

Control Sensor or PCB Relay

1. Turn Digital Mixer off for 15 seconds. Turn back on and allow 15 seconds to reset.



2. If shower operation does not return to normal, replace Thermistor. **(To be performed by competent tradesperson only!)**
3. If shower operation does not return to normal, replace PCB.

(To be performed by competent tradesperson only!)

4. If problem still occurs, make a note of the error code and contact our Customer Services Team.

Digital Mixer Temperature Motor



1. Turn Digital Mixer off for 15 seconds. Turn back on and allow 15 seconds to reset.
2. If shower operation does not return to normal, check and, if necessary, replace Mixer Valve. **(To be performed by competent tradesperson only!)**
3. If problem still occurs, make a note of the error code and contact our Customer Services Team.

Error Code Number Not Previously Described

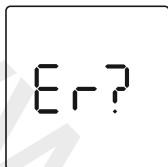

Digital Mixer PCB Error.

1. Turn Digital Mixer off for 15 seconds. Turn back on and allow 15 seconds to reset.
2. If problem still occurs, make a note of the error code and contact our Customer Services Team.



Replace batteries.



Control out of range.

Error During Function Change

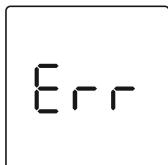

Displayed if there is a signal loss between the Wireless Control Unit and the Digital Mixer whilst a function setting is being altered. Press “⏻” to clear the display and retry the function change.

General Faults

Malfunction	Cause	Remedy
Shower will not operate.	Water supply isolated.	Check water supply.
	Flat batteries.	Replace batteries.
+	Electrical supply isolated or fuse blown.	Check electrical supply. If fuse blown, replace Mixer Valve PCB.
+	No connection to Digital Mixer. Control out of range.	Reset and recommission.
	Digital Mixer malfunction.	Isolate electrical supply and reset after 30 seconds. If problem persists, contact our Customer Services Team.

<p>No flow or low flow from Shower Fittings.</p>	<p>Showerhead blocked. Stuck Checkvalve in Showerhead. Hose blocked or twisted. Digital Mixer malfunction. “L” and or “H” values set too low in Flow Range (F6).</p>	<p>Check and clean. Check and clear or replace Checkvalve. Check and clean or release twist. Contact our Customer Services Team. Change to higher setting.</p>
<p>Drip from showerhead.</p>	<p>A small amount of water may be retained in showerhead after showering. This may drain over a few minutes.</p>	<p>This is normal. Changing position of showerhead may vary draining time.</p>
<p>Shower not hot enough.</p>	<p>Maximum showering temperature set too low. Digital Mixer fitted incorrectly.</p>	<p>Increase maximum showering temperature (Function F1). Make sure hot and cold water supplies are connected correctly and delivering a constant flow and temperature within the required limits. See “Specifications” in the “Mira Vier Installation Guide”. If problem persists, contact our Customer Services Team.</p>

CLEANING

Many household cleaners contain abrasives and chemical substances, and should not be used for cleaning chrome plated or plastic parts. These finishes should be cleaned with a mild washing up detergent or soap solution, and then wiped dry using a soft cloth.

DISPOSAL AND RECYCLING

End of Product Life

When the appliance has reached the end of its serviceable life, it should be disposed of in a safe manner and in accordance with current local authority recycling or waste disposal policy.

Batteries

Spent batteries should not be disposed of with your normal household waste. Contact your local authority for information on waste disposal and recycling.



This symbol on the product or its packaging indicates that this product should not be disposed of with your other household waste. Instead, it is your responsibility to dispose of your waste equipment by handing it over to a designated collection point for the recycling of waste electrical and electronic equipment. The separate collection and recycling of your waste equipment at the time of disposal will help to conserve natural resources and ensure that it is recycled in a manner that protects human health and the environment. For more information about where you can drop off your waste equipment for recycling, please contact your local council office, your household waste disposal service or the shop where you purchased the product.

CUSTOMER SERVICES

Guarantee

Your product has the benefit of our manufacturer's guarantee which starts from the date of purchase. To activate this guarantee, please return your completed registration card, visit our website or free phone 0800 0731248 within 30 days of purchase (UK only).

Within the guarantee period we will resolve defects in materials or workmanship, free of charge, by repairing or replacing parts or product as we may choose. **This guarantee is in addition to your statutory rights and is subject to the following conditions:**

- The product must

be installed and maintained in accordance with the instructions given in this user guide.

- Servicing must only be undertaken by us or our appointed representative. **Note!** if a service visit is required the product must be fully installed and connected to services.
- Repair under this guarantee does not extend the original expiry date. The guarantee on any replacement parts or product ends at the original expiry date.
- For shower fittings or consumable items we reserve the right to supply replacement parts only.

The guarantee does not cover:

- Call out charges for non product faults (such as damage or performance issues arising from incorrect installation, improper use, lack of maintenance, build up of limescale, frost damage, corrosion, system debris or blocked fi lters) or where no fault has been found with the product.
- Water or electrical supply, waste and isolation issues.
- Compensation for loss of use of the product or consequential loss of any kind.
- Damage or defects caused if the product is repaired or modified by persons not authorised by us or our appointed representative.
- Routine maintenance or replacement parts to comply with the requirements of the TMV 2 or TMV 3 healthcare schemes.

What to do if something goes wrong

Helpdesk Service

Our dedicated Customer Services Team is comprehensively trained and can offer help and advice, spare parts, accessories or a service visit. We will need you to have your model name or number, power rating (if applicable) and date of purchase. As part of our quality and training programme calls may be recorded or monitored.

Mira Showers Website (www.mirashowers.co.uk)

From our website you can register your guarantee, download additional user guides, diagnose faults, purchase our full range of accessories and popular spares, refer to our FAQ's and request a service visit.

If your product does not function correctly when you first use it, contact your installer to check that it is installed in accordance with the instructions in Cheltenham, Gloucestershire, GL52 5EP this manual.

Should this not resolve the issue, contact our Customer Services Team who will offer you or your installer advice and

if applicable arrange for a Service Technician to call. Mon to Fri 9:00 am - 5:00 pm If the performance of your product declines, check in this E-mail: sales@modernplant.ie

manual to see if simple home maintenance is required. If you require further assistance call our Customer Services Team.
Fax: Dublin 01 459 2329 By Post: Modern Plant Ltd (Dublin),

Extended Guarantees

Spares and Accessories

We maintain extensive stocks of genuine spares and accessories and aim to provide support throughout the product's expected life. Payment can be made by phone at time of order using most major Credit or Debit cards and we aim to despatch orders within two working days. Items purchased from us are guaranteed for 12 months from date of purchase. For safety reasons spares exposed to mains voltages should only be fitted by competent persons.

Returns – items can be returned within one month of date of purchase, providing that they are in good condition and the packaging is unopened. Please obtain authorisation from our Customer Services Team before return. We reserve the right to apply a 15% restocking charge.

Service / Repairs

We have a nationwide team of Service Technicians who can carry out all service or repair work to your product within the guarantee period and beyond. You have the assurance of a fully trained Mira Technician, genuine Mira spare parts and a 12 month guarantee on any chargeable work done. Payment should be made directly to the Service Technician who will accept most major Credit or Debit cards.

To Contact Us

UK

Telephone: 0844 571 5000

Mon to Fri 8:00 am - 5:30 pm, Sat 8:30 am - 3:30 pm

E-mail: technical@mirashowers.com

Fax: 01242 282595

Eire

Telephone: 01 459 1344

Otter House, Naas Road, Clondalkin, Dublin 22

enable you to cover repair bills for the life of your policy (excludes Eire). Ring 01922 471763 for more details.

Mira is a registered trade mark of
Kohler Mira Limited.

The company reserves the right to alter
product specifications without notice.



FM 14648

mira
SHOWERS

1144487-W2-A (N86C) (1742)

A selection of protection plans are available that

Kohler Mira Ltd. May 2010