

INSTALLATION INSTRUCTIONS

Chelsea straight basin mono tap with pop up waste - CH20

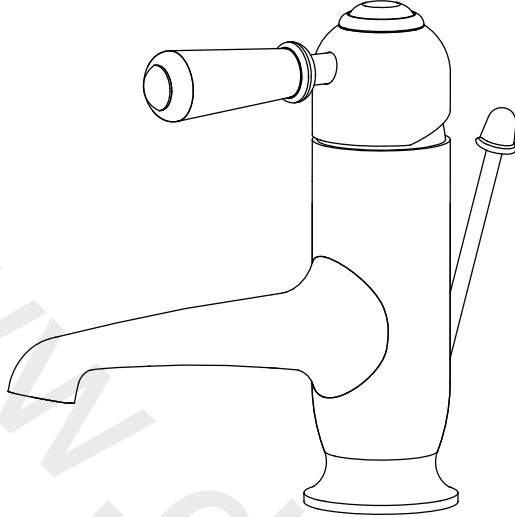

Important

- We recommend that this product is installed by a qualified professional contractor. Such as a plumber who is certified by NVQ (National Vocational Qualification) or SNVQ (Scottish National Vocational Qualification) Level 3.
- Please check this product immediately to ensure that it has not been damaged and is complete. Before installation, please make sure this product is the correct model and you have all the parts required for installation and using.
- All the taps in Burlington Range should be supplied with hot and cold water at balanced pressure. If not, then the mixing function will not work correctly. It is necessary to fit non-return valves on both hot and cold feeds pipe. These are not supplied.
- Please flush the water system to ensure that no metal swarf, solder, and other impurities can enter the taps.
- Turn off water supply before commencing work, this should be done at the isolating valves of inlet feeds if fitted or main stopcock.
- Please read these instructions carefully and keep it for future reference.

Working pressure

The tap is suitable for both high and low pressure installation. To ensure that the tap works well under low water pressure, the cold water storage tank must be at least 2 meters above the installed position. The maximum static pressure is 10 bar, and operating water pressure is 5 bar. Where the operating water pressure above 5 bar, then a pressure reducing valve must be fitted.

Straightener and aerator (alternative option)

The tap comes with a factory-fitted flow straightener for low pressure water systems. If the water flow is high, replace the factory-fitted flow straightener with the high pressure aerator supplied.

Use NEOPERL Key to unscrew the straightener in the Nozzle. Replace with the aerator provided, and screw back in nozzle tightly. (If you misplace the Neoperl key you can use the top of the aerator/straightener as a key)



FLOW STRAIGHTENER

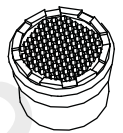

AERATOR

Cleaning

Before use: Unscrew the filter and allow the water to run freely for 5 minutes. Then screw the filter back in place.

Periodically: Using the key provided unscrew the nozzle and remove. Rinse it with cleaning running water until any loose debris is cleared. Then replace the nozzle and tighten with key provided.

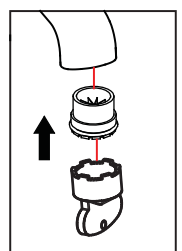
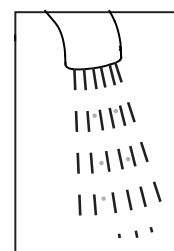
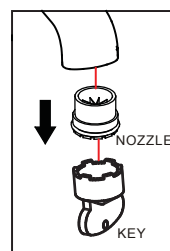

Maintenance

We do NOT recommend you use any household cleaners to clean the product. Because these cleaners change substance or formula too frequently. The product should be always cleaned only with soapy water and rinsed with clean water and dried with a soft cloth.

Dimension

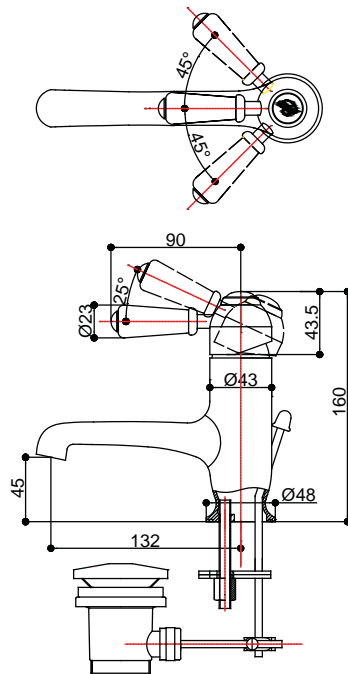

Installation

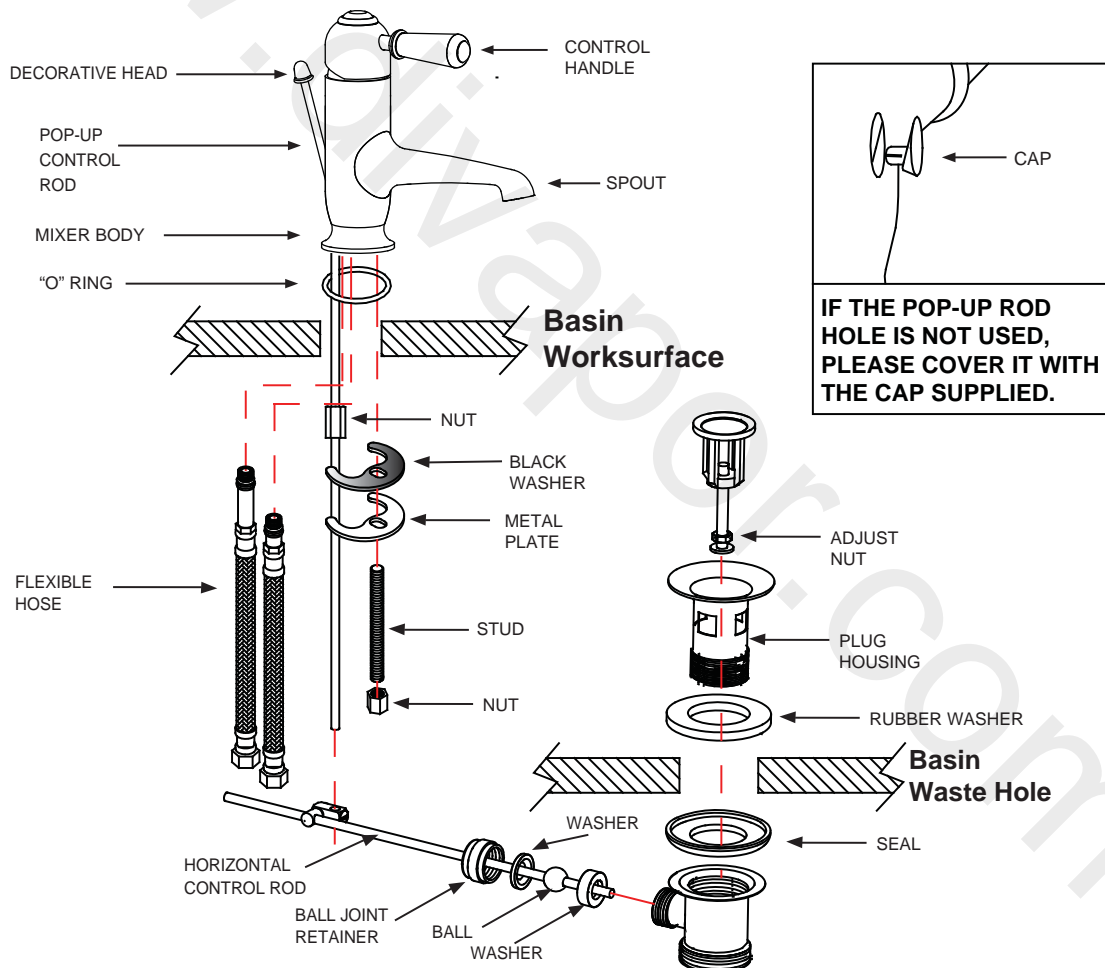

1. Fit the "O" ring into the groove on the underside of the mixer body.
2. Screw and tighten two flexible hose into the mixer body. Loosen the nut from stud and screw the stud into the base of mixer.
3. Pass the flexible hoses and stud through the hole in basin. Slide the black washer and metal plate onto the stud. Then screw on the nut and tighten the mixer on basin.

4.1 Install Pop-Up Waste:

- a) Remove the Pop-up control rod decorative head. Screw two pop-up control rods together by nut.
- b) Insert the Pop-Up control rod into the mixer body from underneath the basin.
- c) Insert the pop up waste on the basin and tighten.
- d) Insert the horizontal control rod into the waste, and tighten the ball joint retainer to make sure the ball with two washers on both sides are fixed with the waste.
- e) Connect the pop-up control rod with the horizontal control rod.
- f) Test the pop-up waste function, adjust the connection between pop-up control rod and horizontal control rod, or the ball joint retainer if necessary. Put back the Pop-up decorative head.