

36 607 809









- rosette Ø 60 mm
- head part with cut-to-length spindle and sleeve

**Codes & standards**

**Fits VAIA**

Fits VAIA



	Brushed Platinum	36 607 809-06
	Chrome	36 607 809-00
	Platinum	36 607 809-08
	Dark Chrome	36 607 809-19
	Brushed Durabronze (23kt Gold)	36 607 809-28
	Brushed Champagne (22kt Gold)	36 607 809-46
	Champagne (22kt Gold)	36 607 809-47
	Brushed Dark Platinum	36 607 809-99

**Required miscellaneous**



**Wall valve 1/2"**

35 607 970 90

- min. recess depth 75 mm
- max. recess depth 145 mm

36 607 809

mm [inches]

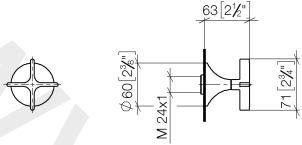

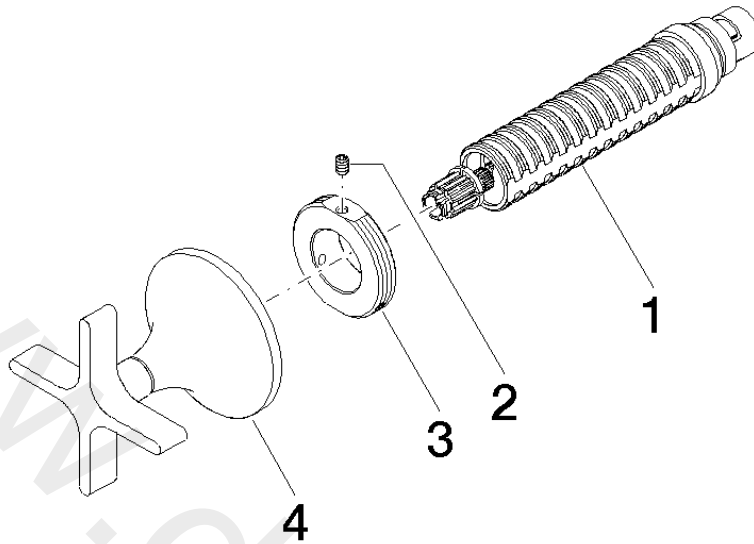

Spare parts list

No.	Item Number	Name	Quantity used	Delivery time
1	90 90 03 143 00 90	top	1	2
2	09 31 11 008 90	pin	1	2
3	09 21 02 163 90	disc	1	2
4	90 20 80 014 00-06	handle	1	10