

Wall valve clockwise closing 1/2"

CL.1

36 607 740









- without rosette
- handle Ø 60mm
- without marking
- head part with cut-to-length spindle and sleeve

Codes & standards

Fits CL.1, META, CYO

Fits: CL.1, META, CYO

Fits CL.1, META, CYO

	Brushed Platinum	36 607 740-06
	Chrome	36 607 740-00
	Dark Chrome	36 607 740-19
	Brushed Durabronze (23kt Gold)	36 607 740-28
	Matte Black	36 607 740-33
	Brushed Chrome	36 607 740-93
	Brushed Dark Platinum	36 607 740-99

Required miscellaneous



- Wall valve 1/2"** 35 607 970 90
- min. recess depth 85 mm
 - max. recess depth 145 mm

36 607 740

mm [inches]

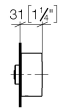
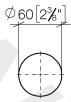

www.divapor.com

36 607 740

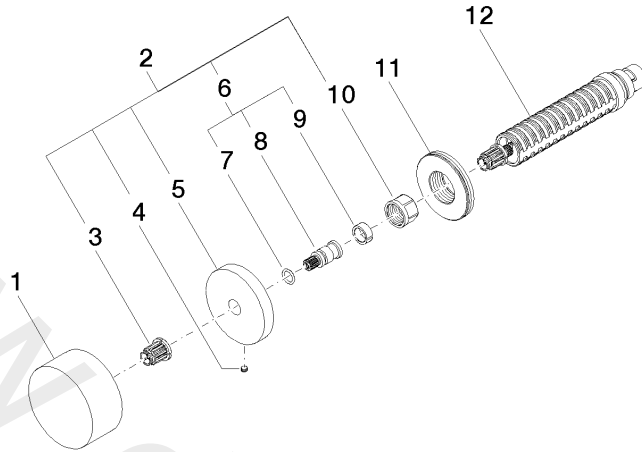

Spare parts list

No.	Item Number	Name	Quantity used	Delivery time
1	09 20 74 004-06	handle	1	60
2	04 27 74 004 00-06	rosette	1	10
3	90 12 12 002 00 90	fixing cap	1	2
4	09 31 11 055 90	pin	1	2
5	09 27 74 004-06	rosette	1	10
6	04 29 06 020 00-00	spindle	1	10
7	09 14 10 060 90	seal	1	2
8	09 29 06 020-06	spindle	1	-
9	09 14 15 020 90	ring	1	2
10	09 23 30 023 90	nut	1	2
11	09 30 01 107 90	sleeve	1	2
12	90 90 03 143 00 90	top	1	2