

# WATERWAYS BRASSWARE

---

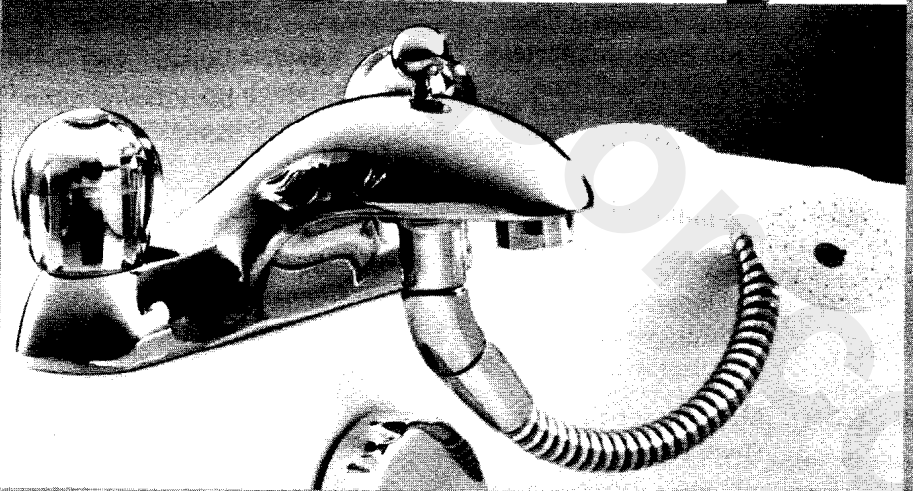
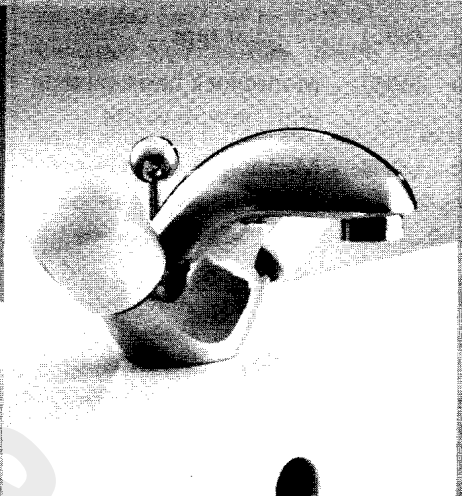

**Installation Instruction**

---

## CONVENTIONAL BRASSWARE

EURO CODE	PRODUCT
E6840 (684)	½" pillar taps
E6850 (685)	¾" pillar taps
E6860 (686)	Monoblock basin mixer with pop-up waste
E6870 (687)	Monoblock basin mixer complete with weighted chain
E6715 (671)	Monoblock swivel spout basin mixer, with pop-up waste
E6880 (688)	Monoblock basin filler, (Twin Flow), with pop-up waste
E6890 (689)	Monoblock basin filler, (Twin Flow), complete with weighted chain
E6900 (690)	Monoblock bidet mixer with pop-up waste
E6910 (691)	Roll mounted bath filler, (Twin Flow)
E6920 (692)	Roll mounted bath/shower mixer complete with shower kit
E7040 (704)	Monoblock bath filler, (Twin Flow)
E7050 (705)	Monoblock bath/shower mixer complete with shower kit

## QUARTER TURN CERAMIC DISC BRASSWARE

EURO CODE	PRODUCT
E0655 (065)	½" pillar taps
E0665 (066)	¾" pillar taps
E0675 (067)	Monoblock basin mixer with pop-up waste
E0625 (062)	Monoblock swivel spout basin mixer, with pop-up waste
E0685 (068)	Monoblock basin filler, (Twin Flow), with pop-up waste
E0695 (069)	Monoblock bidet mixer with pop-up waste
E0705 (070)	Roll mounted bath filler (Twin Flow)
E0715 (071)	Roll mounted bath/shower mixer complete with shower kit
E0635 (063)	Monoblock bath filler, (Twin Flow)
E0645 (064)	Monoblock bath/shower mixer complete with shower kit

The above are supplied less handles. A choice of handles is available and these are supplied separately.

## GENERAL NOTES

Please read this instruction carefully before commencing installation

- The fittings must always have the cold water supply on the right and the hot supply on the left when facing the fitting

- Hot and cold connections for bath pillar taps, deck mounted bath filler and bath/shower mixer are  $\frac{3}{4}$ ".

Connections for basin pillar taps are  $\frac{1}{2}$ ".  
Monoblock bath mixers have 15mm screw-in copper tail pipes.

Monoblock basin and bidet mixers have 1 Omm screw-in copper tail pipes.

## INSTALLATION REQUIREMENTS

As the incorrect installation of water fittings may result in contravention of the Water Byelaw requirements the following **INSTALLATION REQUIREMENTS & NOTES (IRN)** are intended as guides to water undertakers and consumers, installers and their customers. These IRN's relate to the new Byelaws implemented by water undertakers from 1 st January 1989. For further information see "Water Supply Byelaws Guide" published by the water Research Centre (International Book No. ISBN 1 870779 02 9).

The following IRN's apply only to the fittings listed.

Basin mixer                      IRN No. 101

Bidet mixer                      IRN No. 140

Bath/shower mixer IRN No. 104

Refer to list included for details of IRN's.

## WATER SUPPLIES

Bath, basin and bidet fittings are designed for installation on normal UK low pressure storage tank fed systems or unvented high pressure systems. With mixers it is a requirement that hot and cold supply pressures be reasonably balanced for both low pressure and unvented high pressure systems for optimum performance.

Basin and bath fittings are designed to operate on supply pressures from 0.1 bar minimum to 5 bar maximum. Bidet fittings are designed for 0.2 bar minimum to 5 bar maximum. To ensure safety with a bath/shower mixer and bidet installed on normal UK low pressure storage tank fed systems it is recommended that the cold water feed from the storage tank is connected below the feed to the hot water storage cylinder.

In the event of a float-operated valve failure or mains supply failure the hot water will cease to flow before the cold.

The bath/shower mixer has a bath to shower diverter with check valve to comply with IRN No. 104 (Byelaw 17). If the bath/shower mixer is installed in accordance with IRN No. 101, and the handspray is constrained above the spillover level of the bath, the check valve can be removed and an increased shower flow rate will result. See (Fig. 3).

All mixer fittings are supplied with flow straighteners fitted in the spout and a Neoperl aerator/flow restrictor (not supplied) should be fitted when the supply pressure is higher than 1 bar.

These are available from most Ideal-Standard stockists Part No. 096165100.

## PILLAR TAP INSTALLATION

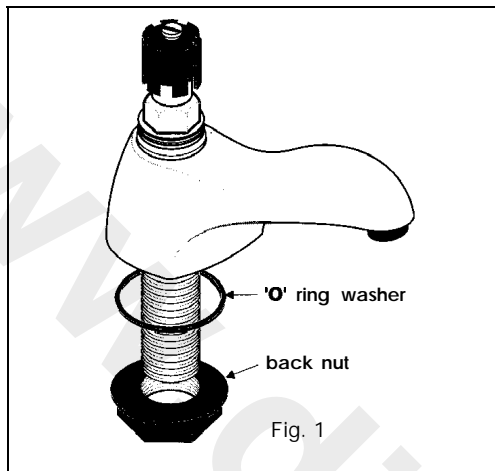

- Flush water through pipework to remove all debris etc. before connecting the fitting.
- Insert fitting into the tap hole, 'O' ring washer above the platform, back nut under the platform.
- Tighten back nut.

## BATH FILLER & BATH/SHOWER MIXER INSTALLATION (2 HOLE)

- Flush water through pipework to remove all debris etc. before connecting the fitting.
- Fit rubber gasket on the fitting body (Fig. 2).
- Insert fitting into the tap holes on the bath.
- Add back nuts and tighten.
- Fit shower hose etc. to the bath/shower mixer (Fig. 3). The swivel elbow should be directed towards the shower hose resting station and secured with the grub screw.

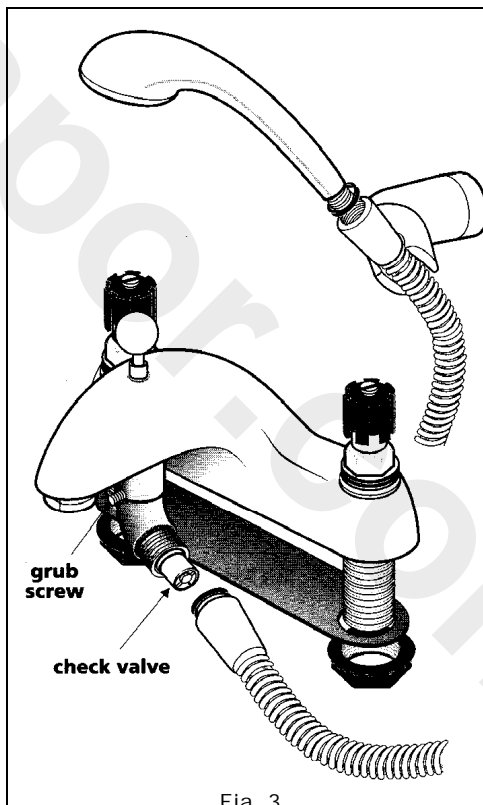
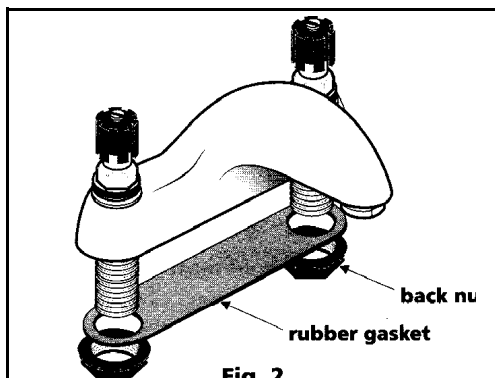

# BATH FILLER & BATH/SHOWER MIXER INSTALLATION (1 HOLE)

Refer to notes on 2 hole bath filler and bath/shower mixer, reference Flushing and fixation of Shower kit etc. The monoblock bath/shower mixer and bath filler are designed for installation on a bath with a single tap hole. For assembly and fixation of the fitting onto the bath, a 50mm tap hole will need to be cut into the bath rim on site, see Fig. 4.

Before fixing the tail pipes, position the mixer on the bath rim and check clearance for handle operation and bath/shower mixer elbow/hose connection. Draw outline around the mixer base

and then find the centre of the hole before drilling the bath. Use 50mm/2" hole saw for this purpose.

N.B.

It is not recommended to fit a monoblock bath fitting in line with the waste and overflow assembly, as this may interfere with the operation and fixation of the overflow. When the monoblock bath fitting is not being fitted on the corner of a bath, clarification of fixation/suitability should be sought from Ideal-Standard's Customer Care Department.

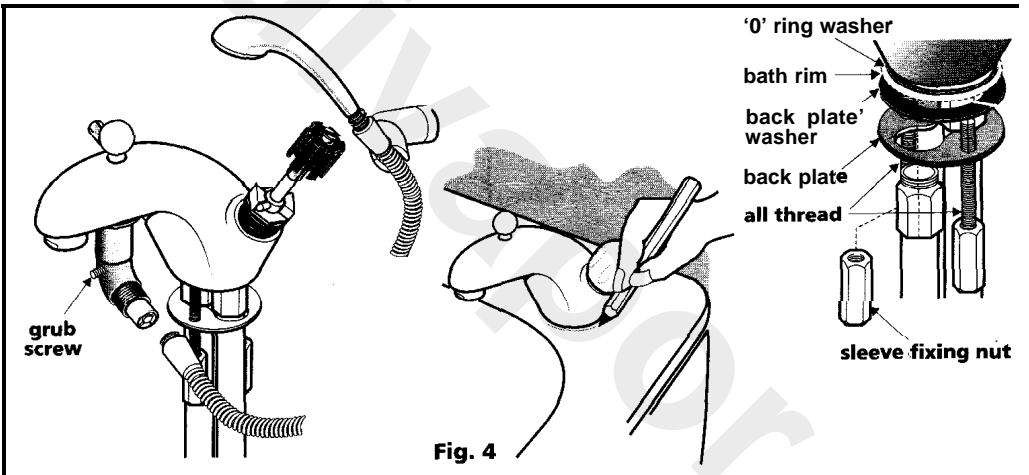

## MONOBLOCK FITTINGS INSTALLATION

- Flush water through the pipework to remove debris etc. before connecting the fitting.
- Insert fitting into tap hole, 'O' ring washer above the platform, back plate washer, back plate and sleeve fixing nut under the platform (Fig. 5).
- Tighten sleeve fixing nut.

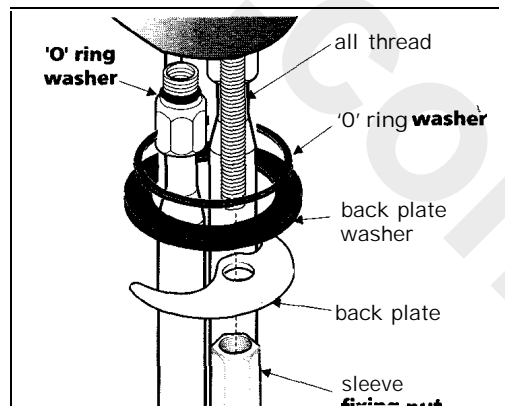

## FIXATION OF SWIVEL SPOUT

The fitting of the spout to the body is a bayonet type fixation.

- Position the spout with the outlet nozzle facing the “Ten o’clock” position so that the ball bearing engages with the groove in the body, (see Fig. 6).
- Push the spout firmly into position and turn spout to the facing position, (see Fig. 7).
- The spout should now move freely in the body.

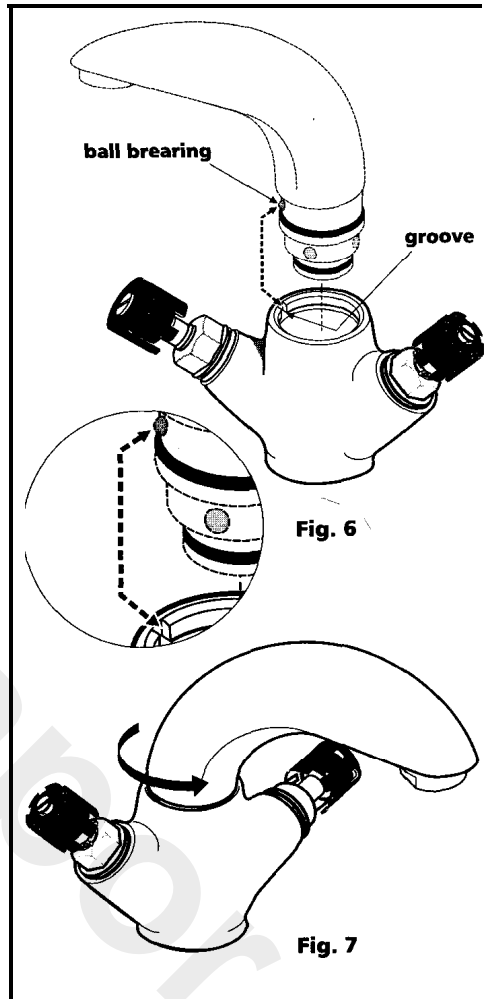

## FIT HANDLES (Figs. 8 & 9)

Fittings in the Waterways Collection are supplied less handles and a choice of acrylic, metal and porcelain handles are available.

- To fit snap on handles tighten cone screw to secure handle carrier to spindle. When necessary, it is essential that the handle carrier is secured tightly to the spindle before the handle is fitted otherwise the handle, will be loose and damage could result (see Fig. 8).
- Push handle down on to the handle carrier
- When using the three piece and easy function metal handle options, the handle fits direct onto the cartridge spindle, (see Fig. 9).
- Unscrew handle cap, or remove index button where necessary.
- Fit handle body on to cartridge spindle.
- Tighten cone screw.
- Re-fit handle cap or handle index.

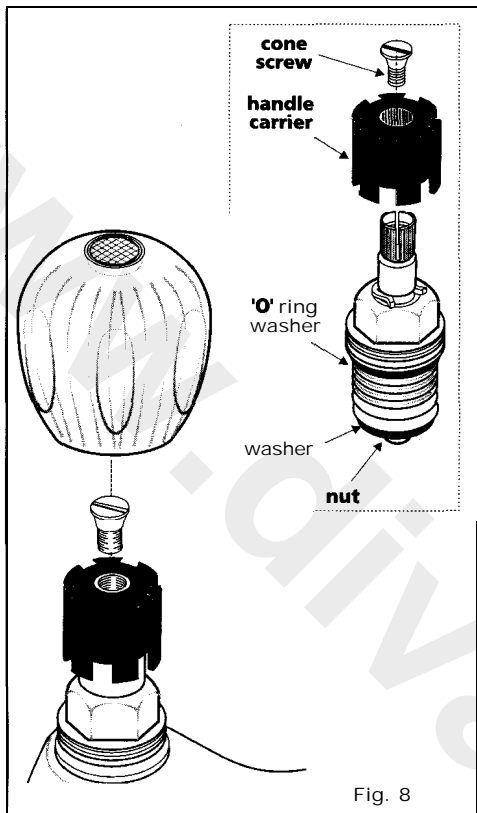

Fig. 8

## SAFETY FOR THE USER

- The fittings featured are not thermostatically controlled and outlet temperature depends on the position of the handle, hot and cold inlet temperatures and pressures. If the cold water supply fails only hot water at its maximum temperature will be delivered if connections to the cold water storage tank have not been made as recommended under WATER SUPPLIES.
- Before bathing or hand washing check that the temperature of the mixed water is satisfactory.
- Young children, the elderly and infirm should be supervised when using a bath, hand spray or bidet.

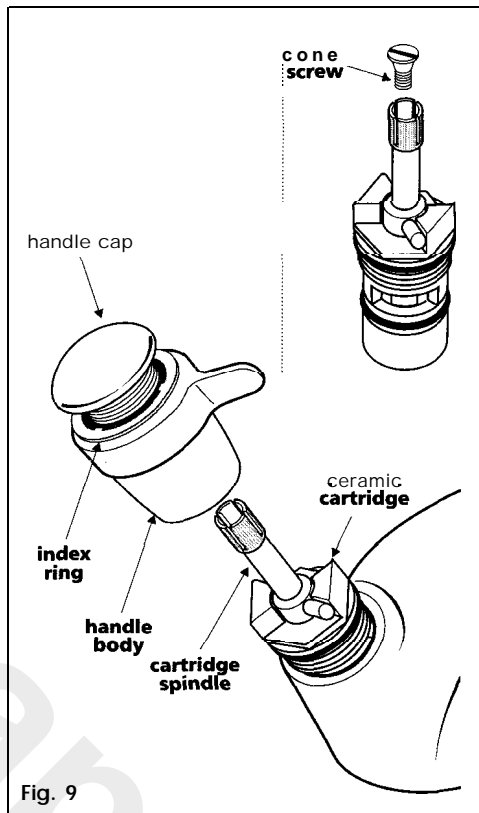

Fig. 9

## OPERATION

### CONVENTIONAL BRASSWARE

Turn the handles anti-clockwise to bring the fitting up to the full flow, or to any intermediate position as required.

### CERAMIC DISC BRASSWARE

Separate ceramic disc cartridges control the flow of hot and cold water. Turn the handle through 90° to move from off to fully on.

### BATH/SHOWER MIXER

The bath/shower mixer incorporates a manually operated self cancelling diverter. Lift diverter knob to transfer to hand spray. The diverter will return to the supply to bath position when the water is turned off.

## MAINTENANCE

To remove conventional valve

- Shut off hot and cold water supplies as required.
- Remove handle.
- Unscrew valve by turning anti-clockwise.
- Replacement valve washers are available from most Ideal-Standard stockists - Part No. 096167200.

To remove ceramic disc cartridge

The unique ceramic disc cartridge contains ultra smooth ceramic discs. They are so hard that they always remain sealed together polishing one another in use, and sand, sediment or other water-borne matter cannot get between them or damage them. Even the hardest water has no effect and this means that the fitting should give many years of efficient, trouble-free service without the drip and liming-up problems associated with traditional taps. However, in the unlikely event of a failure or any problem simply exchange the cartridge. First check the outlet nozzle in the spout for possible blockage due to a build-up of debris etc. from the pipework.

1. Shut off water supply and move handle to the "off" position.

2. Remove handle.

3. Remove cartridge by unscrewing anti-clockwise.

NOTE:

Hot and cold cartridges are not interchangeable. The hot cartridge (marked red) is on the left and the cold cartridge (marked blue) is on the right when facing the fitting. The ceramic disc cartridges in the 1/2" and 3/4" pillar taps have the same 90° orientation.

Spares

Spare components are available from most Ideal-Standard stockists. If you have any difficulty in obtaining spares locally, please contact, Ideal-Standard Limited, The Bathroom Works, National Avenue, Kingston upon Hull, HU5 4HS, England. Tel: (01482) 346461 Fax: (01482) 445886.

Any information reproduced from the Water Research Centre - "Water Fittings and Materials Directory" is with the kind permission of the WRC Water Byelaws Advisory Service.

*Ideal  
Standard*

Ideal-Standard Limited  
The Bathroom Works  
National Avenue  
Kingston upon Hull  
HU5 4HS  
England  
Telephone: (01482) 346461  
Telefax: (01482) 445886.

**CUSTOMER CARE HELPLINE**

**01482 499380**

**FAX LINE 01482 499611**

Ideal-Standard pursues a policy of continuing improvement in design and performance of its products. The right is, therefore, reserved to vary specifications without notice.

Ideal-Standard is a trademark of Ideal-Standard Limited.

A Division of American Standard (UK) Co.

4033 8/98