

Features

- One-piece, self-contained ceramic disc valve allows both volume and temperature control
- High-temperature limit setting for added safety
- 6-1/4" (159 mm) spout reach
- Straight handle
- Touch-activated drain with tailpiece and no overflow
- 1.2 gpm (4.5 lpm) maximum flow rate at 60 psi (4.14 bar)

Material

- Brass

Installation

- Single-hole mounting

Recommended Products/Accessories

- K-23726 Drain treatment
- K-23723 Faucet cleaner
- K-14375 24" Double Towel Bar
- K-14377 Pivoting toilet paper holder
- K-14435 18" Towel Bar
- K-14436 24" Towel Bar
- K-14441 Towel Ring
- K-14443 Robe Hook
- K-14444 Vertical toilet paper holder



Codes/Standards









- ASME A112.18.1/CSA B125.1
- NSF/ANSI/CAN 61
- NSF/ANSI/CAN 372
- All applicable US Federal and State material regulations
- DOE - Energy Policy Act 1992
- EPA WaterSense™
- California Energy Commission (CEC)

KOHLER® Faucet Lifetime Limited Warranty

See website for detailed warranty information.

Available Colors/Finishes

Color tiles intended for reference only.

| Color | Code | Description |
|---|------|--------------------------------|
|  | CP | Polished Chrome |
|  | SN | Vibrant™ Polished Nickel |
|  | AF | Vibrant™ French Gold |
|  | BN | Vibrant™ Brushed Nickel |
|  | BV | Vibrant™ Brushed Bronze |
|  | BL | Matte Black |
|  | 2MB | Vibrant™ Brushed Moderne Brass |
|  | RGD | Vibrant Rose Gold |

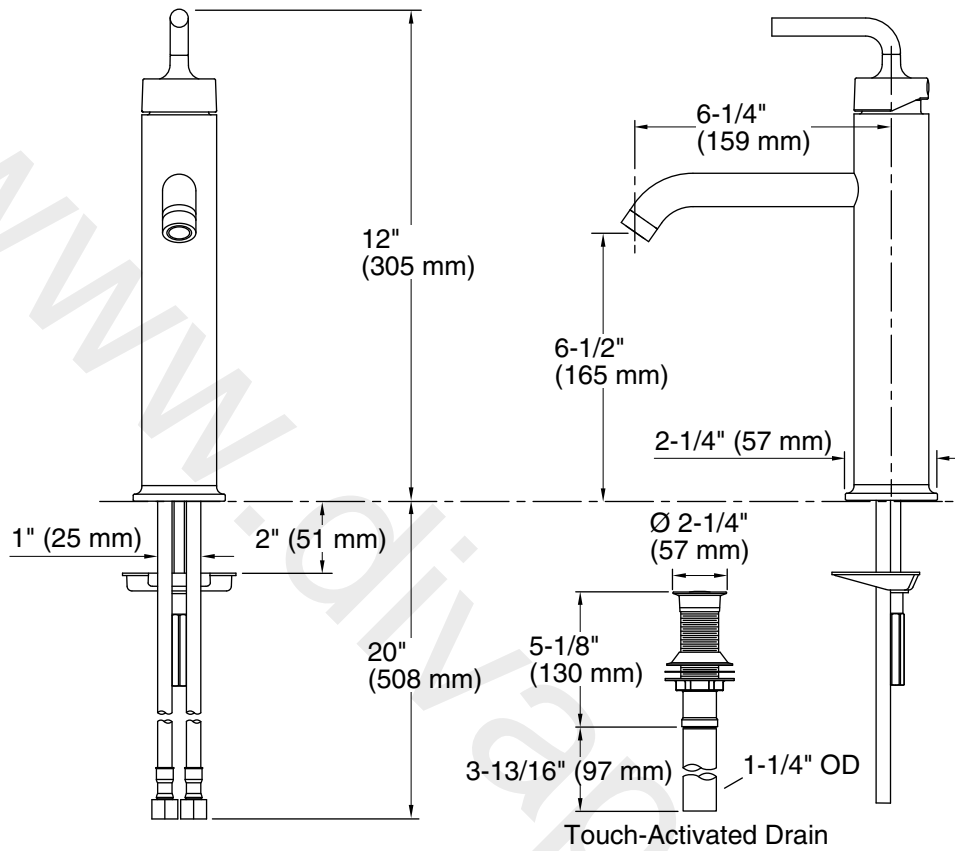

Technical Information

All product dimensions are nominal.

Faucet:

Flow rate: 1.2 gal/min (4.5 l/min)

Pressure: 60 psi (4.1 bar)

Drain included: Yes

Spout:

Spout reach: 6-1/4" (159 mm)

Notes

Install this product according to the installation guide.