

KOHLER® Faucets Rite-Temp™ bath and shower trim kit with push-button diverter and cross handle, without showerhead

Purist™

K-T14420-3L

Features

- Includes faceplate with handle, bath spout, shower arm and flange
- A single handle controls both on/off activation and temperature setting
- Cross handle
- Integrated push-button diverter
- Includes nondiverter bath spout with 1/2" NPT connection
- For use with any KOHLER showerhead (sold separately)
- Complements Purist faucets and accessories

Material

- Premium material construction with metal handle ensures reliability and durability
- KOHLER finishes resist corrosion and tarnishing

Installation

- Trim only; requires valve to complete installation (sold separately)

Recommended Products/Accessories

K-23723 Faucet cleaner

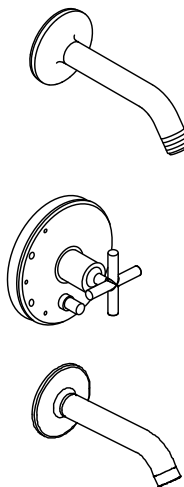

ADA

Codes/Standards





ASME A112.18.1/CSA B125.1
ADA

KOHLER® Faucet Lifetime Limited Warranty

See website for detailed warranty information.

Available Colors/Finishes

Color tiles intended for reference only.

| Color | Code | Description |
|---|------|--------------------------|
|  | CP | Polished Chrome |
|  | SN | Vibrant™ Polished Nickel |
|  | BN | Vibrant™ Brushed Nickel |
|  | BV | Vibrant™ Brushed Bronze |
|  | BL | Matte Black |

KOHLER Faucets Rite-Temp™ bath and shower trim kit with push-button diverter and cross handle, without showerhead
Purist™
K-T14420-3L

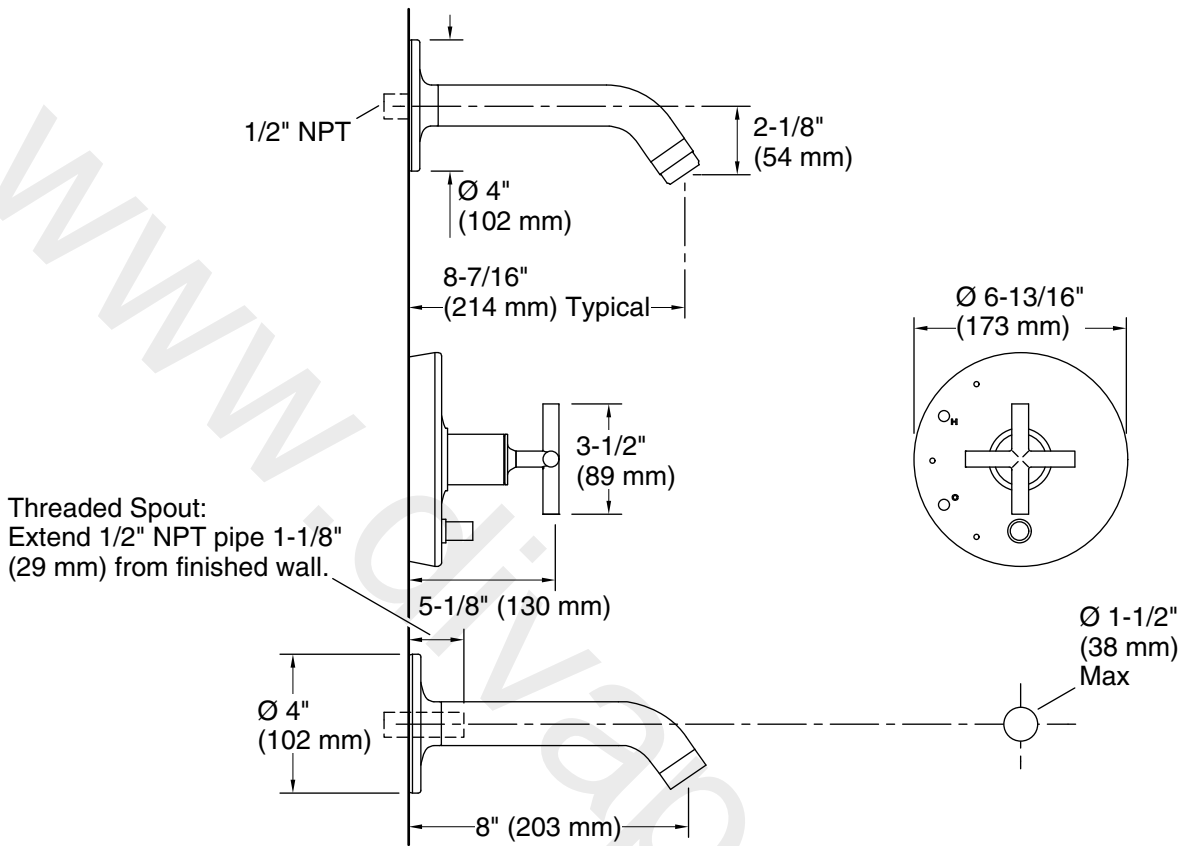

Technical Information

All product dimensions are nominal.

Notes

Install this product according to the installation instructions.

Avoid cross-flow conditions. Do not install shut-off device on either valve outlet.

Cap the shower outlet if deck-mount spout, diverter, or handshower is connected to the spout outlet.

ADA compliant when installed to the specific requirements of these regulations.