

Features

- When used with K-728 Series MasterShower diverter valves, handle controls flow to two or three outlets individually or any two outlets at a time
- When used with K-737 Series MasterShower diverter valves, handle controls flow to two or three outlets individually or only one outlet at a time.
- Valve (not supplied) can be configured on site for 2- or 3-outlet operation
- Complements Artifacts faucets and accessories

Material

- KOHLER finishes resist corrosion and tarnishing
- Premium material construction with metal handle ensures reliability and durability

Installation

- Trim only; requires valve to complete installation (sold separately)
- Patented K-joint installation technology ensures consistent trim appearance, regardless of variability in valve rough-in
- Trim only; requires K-728-K MasterShower™ 2- or 3-way transfer valve or K-737-K MasterShower™ 2- or 3-way diverter valve (sold separately)

Recommended Products/Accessories

- K-728-K 3/4" Two- or Three-Way Transfer Valve
- K-737-K 3/4" Two- or Three-Way Diverter Valve
- K-23723 Faucet cleaner



ADA

Codes/Standards







ASME A112.18.1/CSA B125.1
 ADA
 ICC/ANSI A117.1

KOHLER® Faucet Lifetime Limited Warranty

See website for detailed warranty information.

Available Colors/Finishes

Color tiles intended for reference only.

Color	Code	Description
	CP	Polished Chrome
	SN	Vibrant™ Polished Nickel
	BN	Vibrant™ Brushed Nickel
	BV	Vibrant™ Brushed Bronze
	2BZ	Oil-Rubbed Bronze
	2MB	Vibrant™ Brushed Moderne Brass

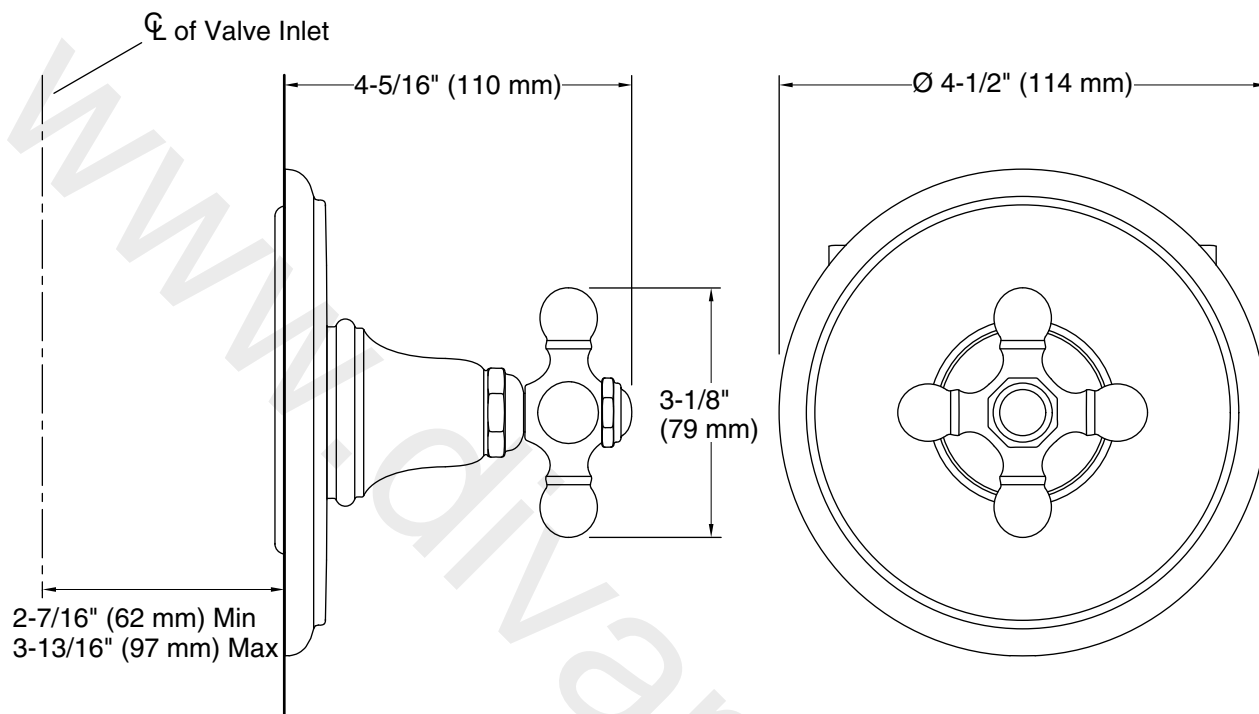

Technical Information

All product dimensions are nominal.

Notes

Install this product according to the installation instructions.

ADA compliant when installed to the specific requirements of these regulations.