

### Features

- Includes faceplate with handle
- A single handle controls both on/off activation and temperature setting
- Cross handle
- Complements Purist faucets and accessories

### Material

- Premium material construction with metal handle ensures reliability and durability
- KOHLER® finishes resist corrosion and tarnishing

### Installation

- Trim only; requires valve to complete installation (sold separately)

### Required Products/Accessories

K-2971-KS 3/4" Pressure-balancing Valve

### Recommended Products/Accessories

K-23723 Faucet cleaner

### Optional Products/Accessories

K-10350 Deep rough-in kit

K-10351 Test cap for K-8300 Series valve bodies

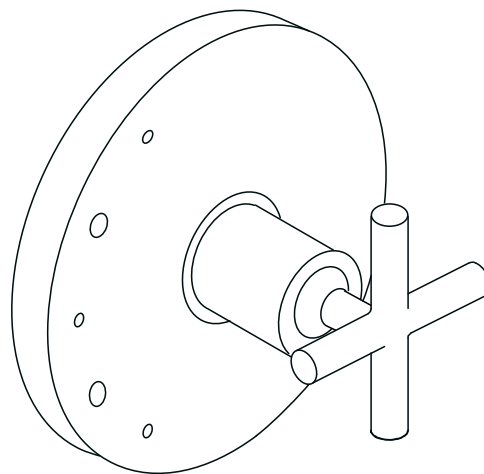

ADA

### Codes/Standards

ASME A112.18.1/CSA B125.1

ADA





ICC/ANSI A117.1

### KOHLER® Faucet Lifetime Limited Warranty

See website for detailed warranty information.

### Available Colors/Finishes

*Color tiles intended for reference only.*

Color	Code	Description
	CP	Polished Chrome
	SN	Vibrant™ Polished Nickel
	BN	Vibrant™ Brushed Nickel
	BV	Vibrant™ Brushed Bronze
	BL	Matte Black

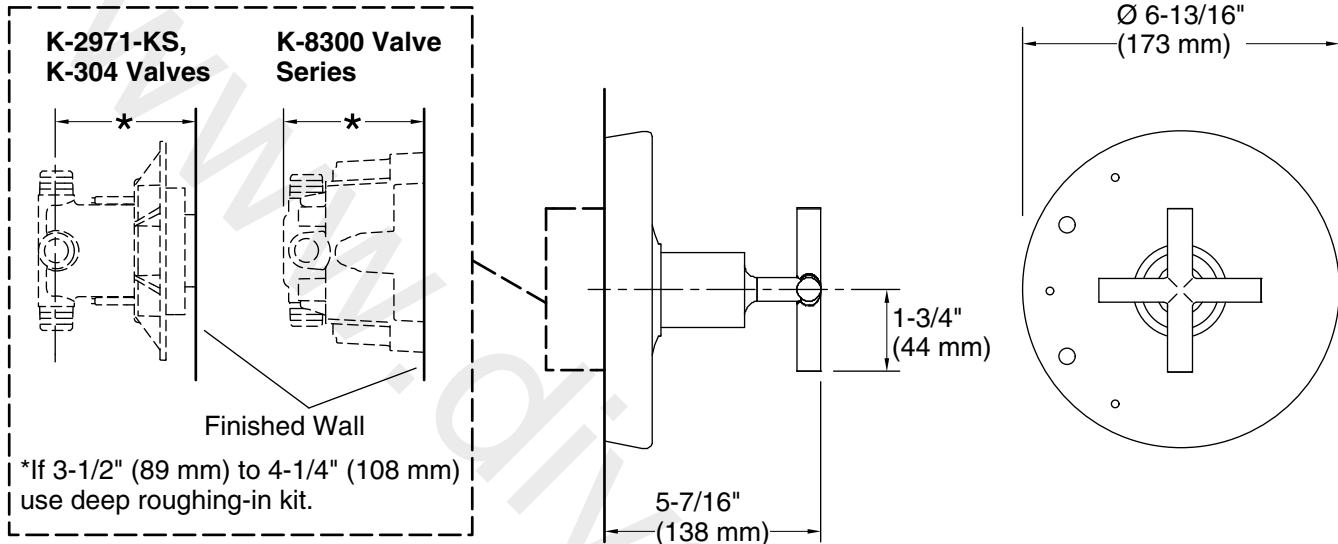

**Technical Information**

All product dimensions are nominal.

**Showerhead/Body Spray:**

Rated maximum flow: 2.5 gal/min (9.5 l/min)

**Notes**

Install the product according to the installation guide.

NOTICE: Risk of product damage. Long screws for installing trim can damage the K-2971-KS valve. Consult the trim installation guide to verify if the thin wall installation kit (88526) is needed.

ADA compliant when installed to the specific requirements of these regulations.