

*Armitage
Shanks*

INSTALLATION INSTRUCTIONS

SANDRINGHAM 21 self closing basin pillar taps



Commercial Self closing ½" chrome plated basin pillar taps
Supplied in pairs – S 0672 AA
Single – S 0673 AA

Introduction

These self closing taps are designed for water economy.
The taps are operated by simply pressing down on the handles.
Once actuated the taps will run for approximately 12 to 16 seconds &
then automatically shut off.
The taps are designed to be supplied with pre-mixed or cold water.

IMPORTANT
BEFORE CONNECTION, FLUSH WATER THROUGH PIPEWORK TO REMOVE
ALL DEBRIS ETC. WHICH COULD DAMAGE THE VALVE MECHANISM

INSTALLER: After installation please pass this instruction leaflet to user

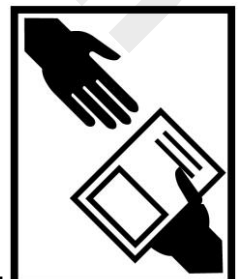

Water regulations

The fittings covered by this installation and maintenance instruction should be installed in accordance with the water regulations published in 1999*, therefore Armitage Shanks would strongly recommend that these fittings are installed by a professional installer

*A guide to the Water Supply (Water Fittings) Regulations 1999 and the Water Byelaws 2000, Scotland is published by WRAS (Water Regulations Advisory Scheme) Fern Close, Pen-y-Fan Industrial Estate, Oakdale, Newport, NP11 3EH. ISBN 0-9539708-0-9

Product dimensions

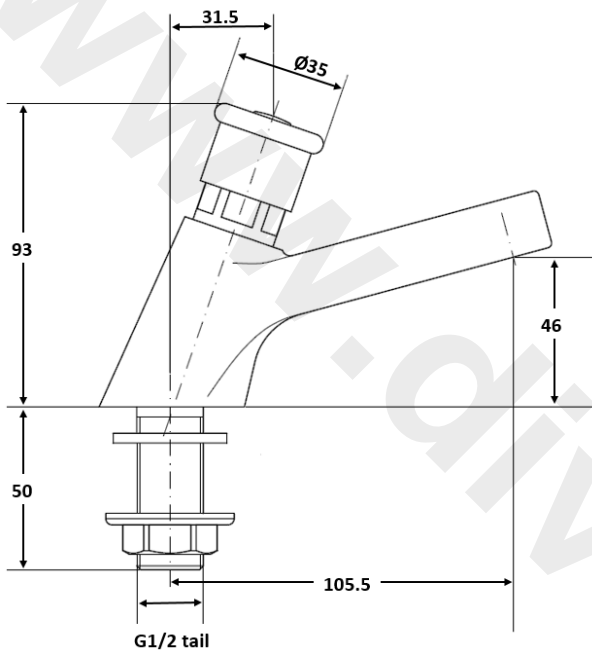

Product box contents:

S 0672 AA

- 2 x Taps (with 1x red & 1x blue index buttons)
- 2 x Brass back-nuts.
- 2 x Base washers
- 2 x 4L/m Flow regulator

S 0673 AA

- 1 x Tap
- 2 x Index buttons (Red & Blue)
- 1 x Brass back-nut
- 1 x Base washer
- 1 x 4L/m Flow regulator

Supply conditions

Avoid supplying scalding water to the HOT tap. Hot water temperature supply should be controlled to circa 40°C.

In order to maintain water quality, the hot supply should be stored & distributed at a temperature greater than 55°C.

Use of an appropriate temperature reduction device (i.e. tee pattern thermostat) is recommended to ensure delivery of safe hot water temperatures from the hot tap.

Minimum working pressure 0.1 bar. Maximum working pressure 5.0 bar.
Fit the flow regulators supplied if the supply pressure is above 1 bar.

Flow regulator orientation

Flow regulator control the flow of water through a fitting at a reasonably constant rate under variable supply pressures. To function correctly it is essential that the flow regulator to be inserted into the water-way in correct orientation. See figure

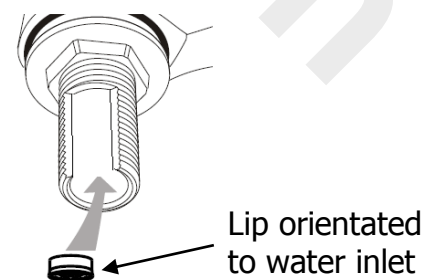



1. Before connection, flush water through pipe-work to remove all debris etc. to prevent damage to the valve mechanism.

THEN ENSURE WATER SUPPLIES HAVE BEEN ISOLATED.

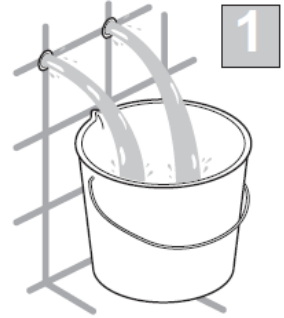

2. Offer tap tails into basin holes, ensuring seals are in place. HOT tap should be fitted on left hand side of the basin (viewed from front).
3. Hand tighten the back-nut from under the basin, ensure the tap spout is positioned correctly, and then tighten the back-nut securely with a tap wrench (24mm A/F).
4. Slip a compression nut & olive onto the Ø15mm supply pipe. Push the supply pipe into the tail up to the shoulder. Slide the olive up to the tail & tighten the compression nut - use a 24mm A/F spanner.
5. RESTORE SUPPLIES & CHECK ALL JOINTS FOR LEAKS

Isolation valves should be fitted to permit future maintenance of this product.

DO NOT apply heat near this product. Heat generated by soldering could damage plastic parts and seals.



Tap operation



To operate this product, simply press the handle downwards & then release. Water will flow for the pre-set time & then the tap will self close.

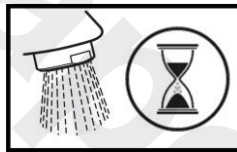

This is a water saving product & is supplied set with a short run time. A run time of typically 12 to 16 seconds will suit most applications. Run time is dependent on water temperature & pressure.

Isolating valves

We recommend isolation valves with filters be fitted to each supply pipe to permit future maintenance of the product. Quote spares code E960086NU. Isolation valves should be installed in an easily accessible location.

When the isolator screw slot is parallel to the valve body, the valve is open & permits water to flow.

To close the valve, rotate the isolator screw 90°. The filter can be checked & cleaned by unscrewing

the cap using a 22mm A/F spanner. Expect some water to escape. The isolating valve can be closed to permit servicing of the taps, or to remove the product.

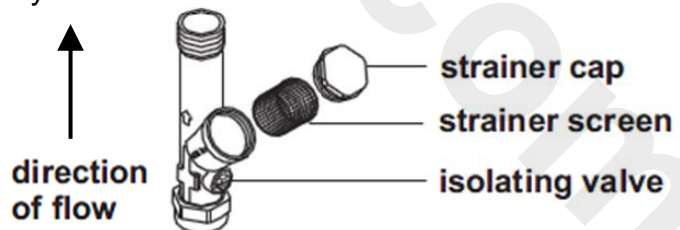

Anti-splash cleaning

On a regular basis the outlet should be inspected & cleaned. Unscrew and remove the outlet. In areas where lime scale build-up is prevalent this should be avoided by regular cleaning. If it should build up, it will have to be removed.

An inhibited proprietary scale solvent can be used such as a kettle de-scaling solvent but it is important to follow the manufacturer's guidelines.

Cleaning chrome surfaces

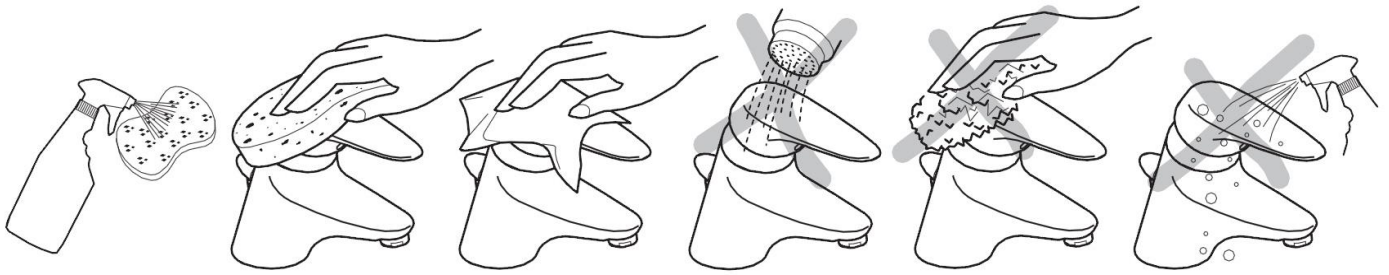

When cleaning chromed products use only a mild detergent, rinse & wipe dry with a soft cloth. Ideally clean after each use to maintain appearance.

Never use abrasive, scouring powders or scrapers. Never use cleaning agents containing ammonia, hydrochloric acid, sulphuric acid, nitric acid, phosphoric acid or organic solvents. Use of incorrect cleaning products / methods may result in chrome damage which is not covered by the manufacturer's guarantee.

Spare parts



Cartridge – A861 170 AA

*Armitage
Shanks*

For more information about our products visit our websites:

www.armitage-shanks.co.uk

www.idealspec.co.uk

www.fastpart-spares.co.uk



AFTER SALES NON RESIDENTIAL HELPLINE

0870 122 8822

AFTER SALES NON RESIDENTIAL FAX

0870 122 8282

E-MAIL

aftersalesnonresidential@idealstandard.com

Armitage Shanks pursues a policy of continuing improvement in design and performance of its products.

This right is therefore reserved to vary specification without notice.

Armitage Shanks is a division of Ideal Standard (UK) Ltd

Ideal Standard International BVBA
Corporate Village – Gent Building
Da Vincilaan 2
1935 Zaventem
Belgium

1116 / A 868 305