

Milano

Square Body Jet

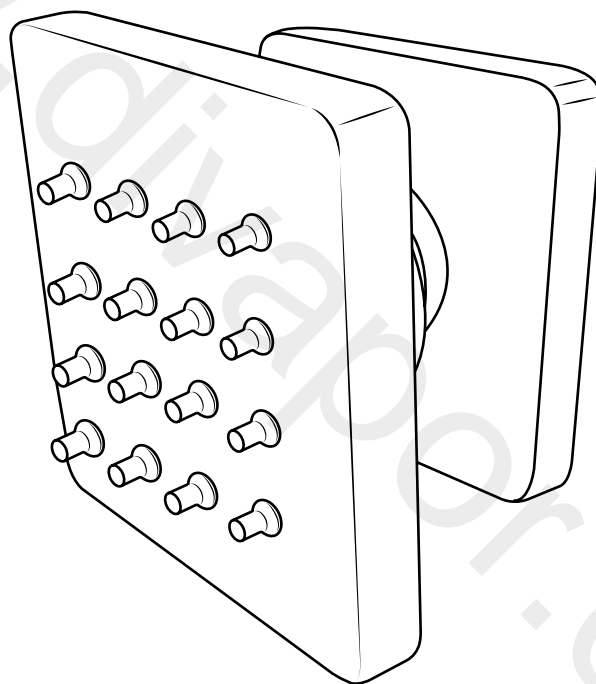

Installation Guide

Installation

Tools required for installing:

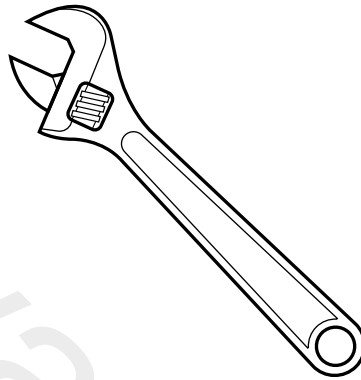
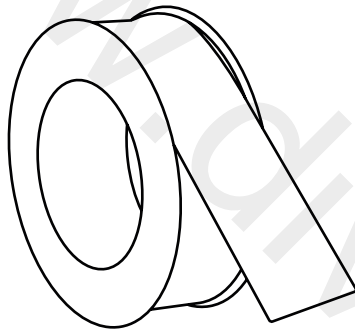
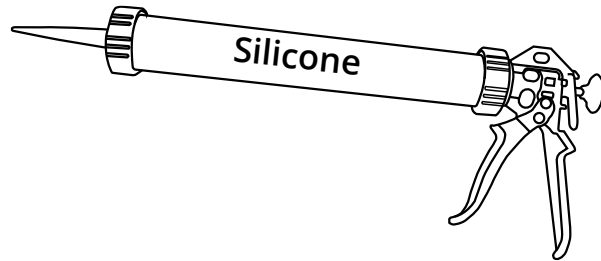

Parts included:

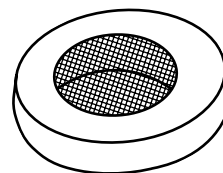
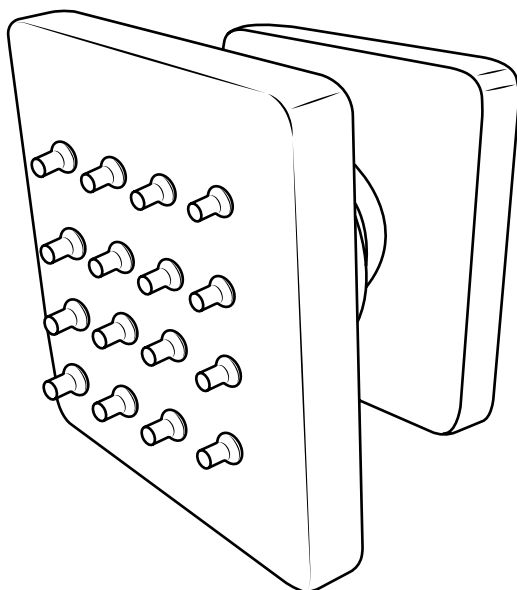

1

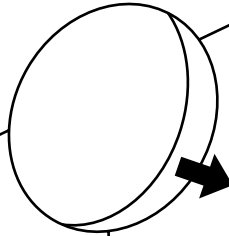
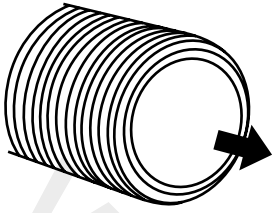

2

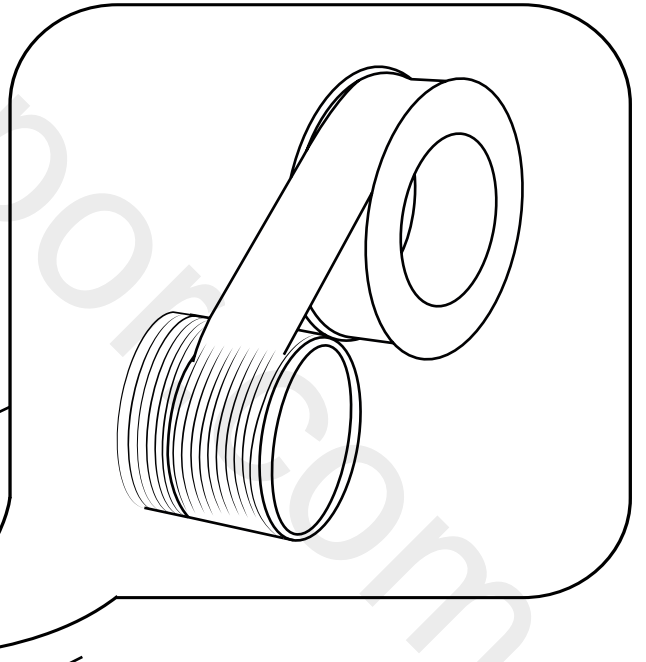
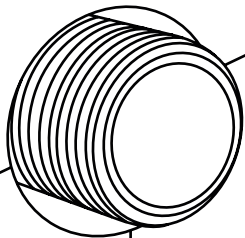

3

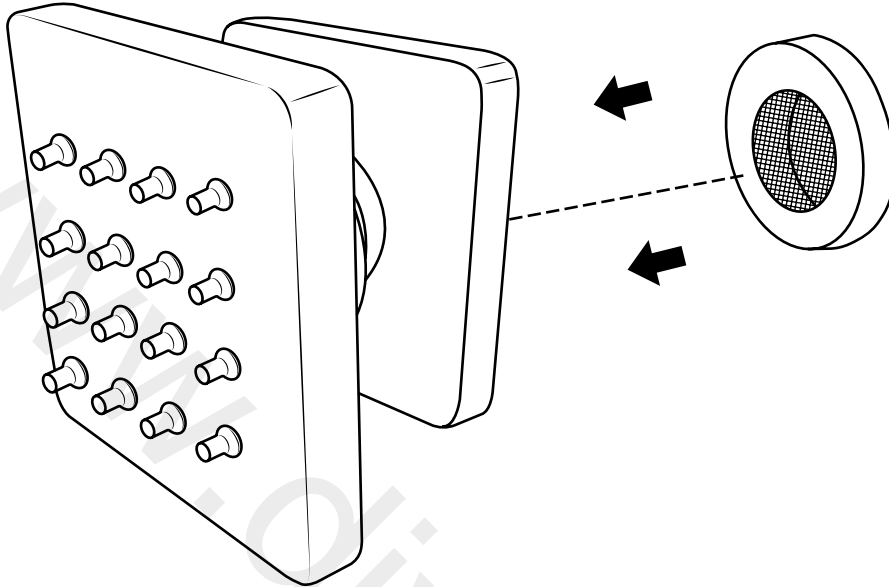

4

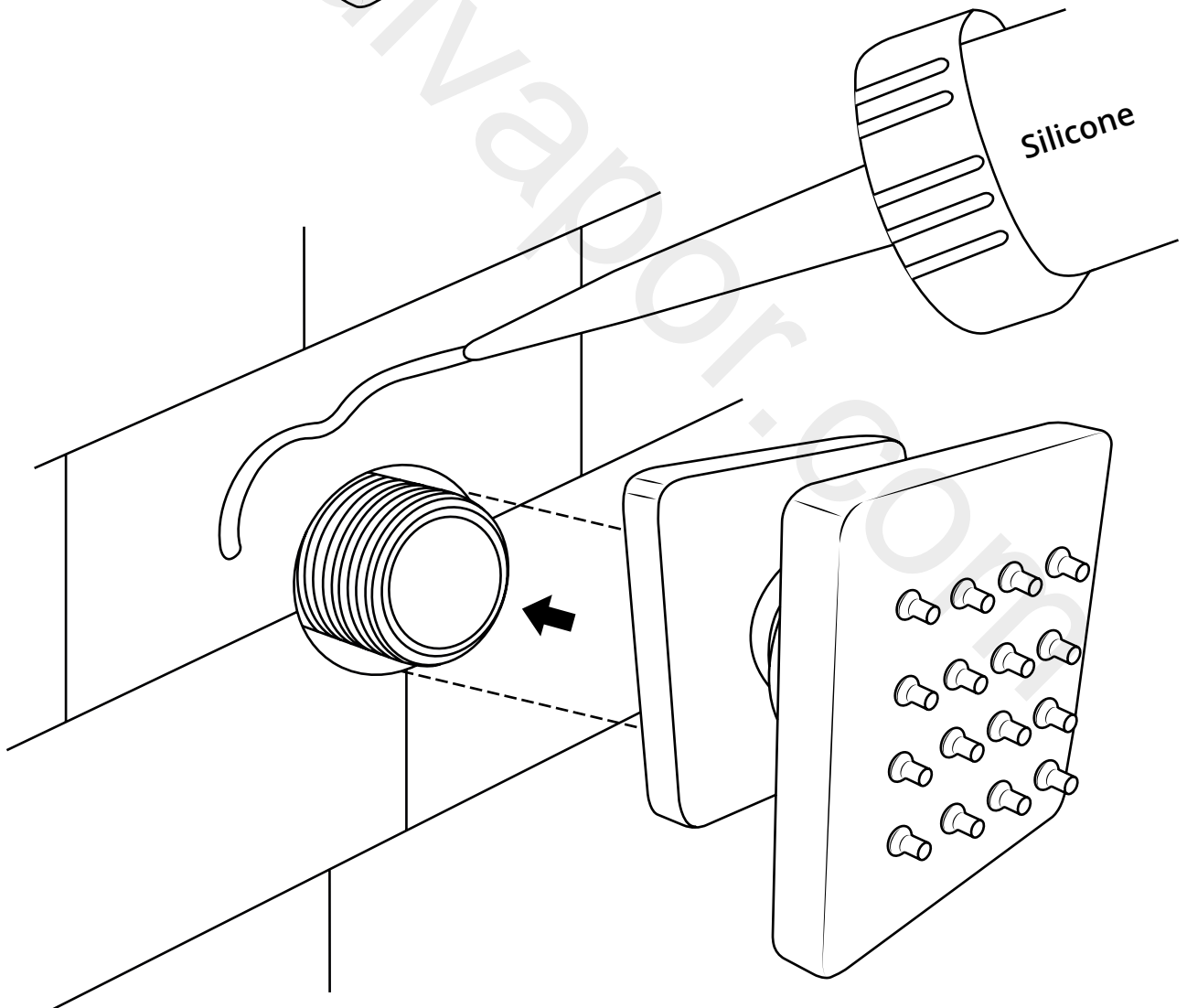

5

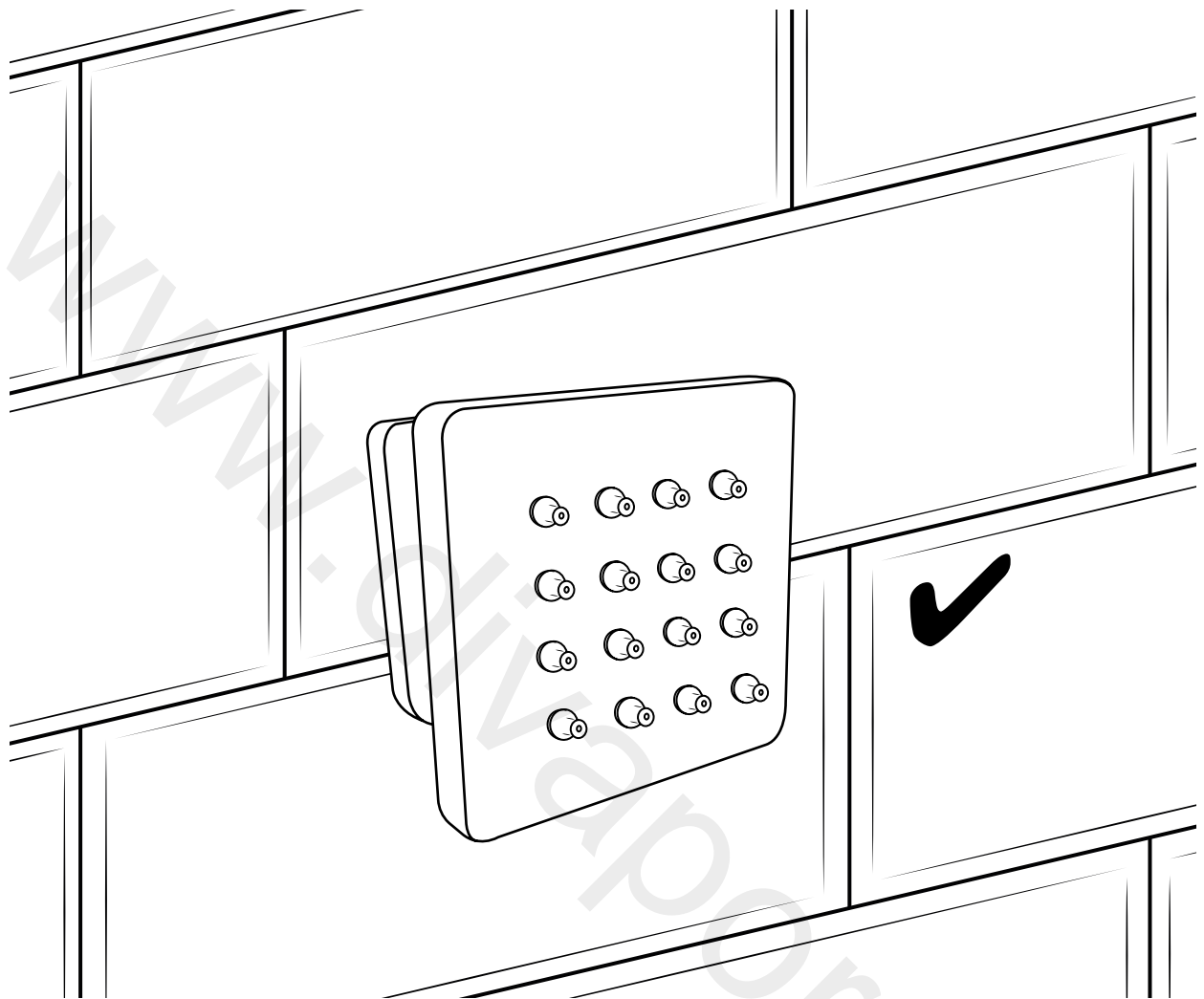

Installation Example

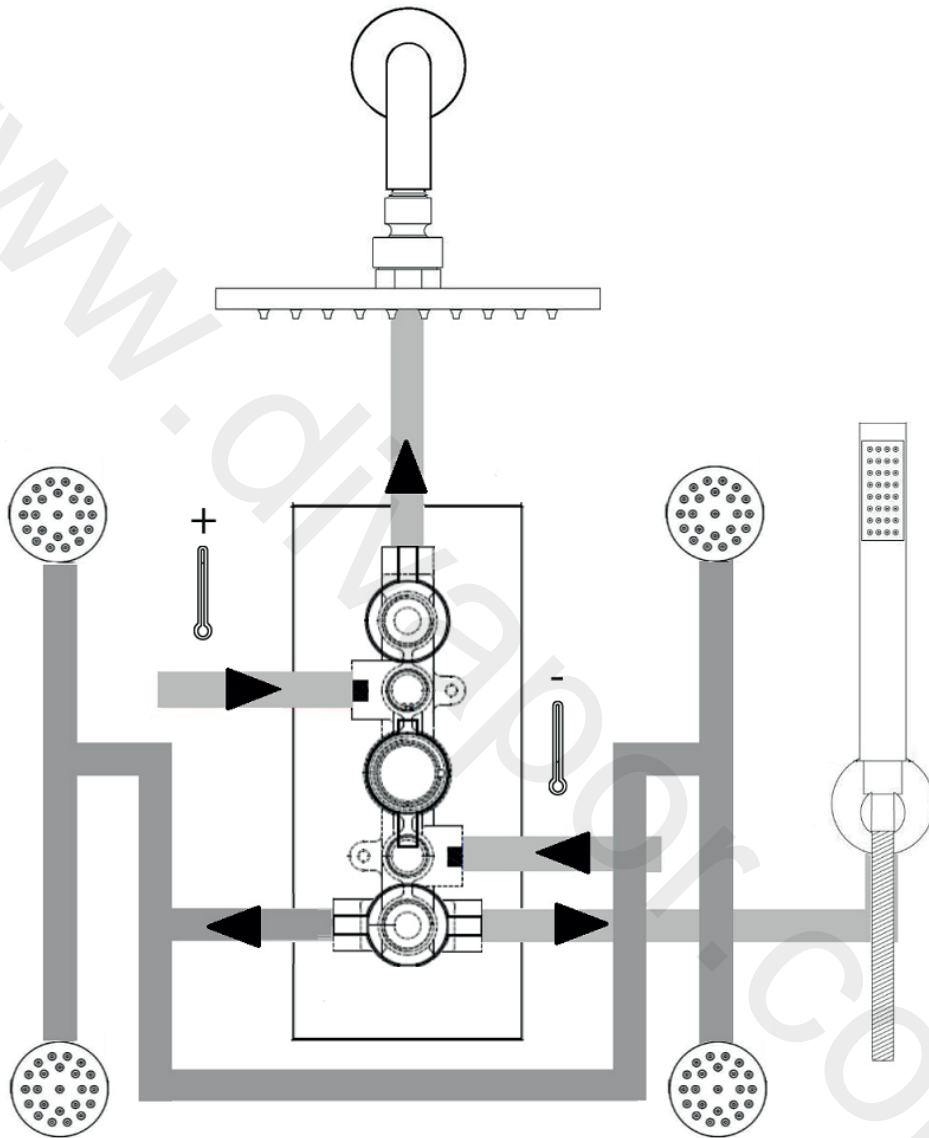

If you require any additional information or have any issues with this product please refer to the website.